

HAWORTH®

May 1, 2020 Update  
All GSA SIN in this price book  
changed to SIN 33721

# Openest® Collection

North America Price List / Specification Guide – February 2020



## Electronic Update Page – Openest Price List

- The table below lists all of the updates and addendums added to this price list since the original version was created.
- All updated pages will replace the existing pages within the document.
- All new Pages will be placed at the back of the document.

Link	Date	Page	Description
<a href="#">Click Here</a>	May 2020	All Price List Pages	<b>Update</b> – GSA SIN number updated in the footer.



# Price Book Overview

The following overview explains how information is organized within this price book.

- 1 Front Cover**
  - Includes the price book title and pricing effectivity date.
- 2 Canadian Conversion / Update Page**
  - Pricing conversion information for converting US pricing into the equivalent Canadian pricing is located on the footer of this page.
  - All Price Book updates will be listed on this page including the date, page number and description of the update.
- 3 Price List Table of Contents**
  - Price List table of contents with page numbers.
- 4 Statement of Line**
  - Provides a pictorial outline of the entire product offering.
- 5 Price List**

Each price list page contains the following:

  - Product Illustration
  - Catalog Number
  - To Order Specify – sequencing for ordering product options and finishes
  - List Prices
  - Product Specification Dimensions
  - Features
  - Specification Tips
  - Class, Discount Group Number (used for discounting) and GSA information
- 6 Specification Guide**
  - Table of Contents – specification guide content with page numbers
  - Statement of Line – provides a pictorial outline of the product offering
  - Product Overview – brief introduction of the product and application intent
  - Easy Planning Steps – basic steps of planning with the product line
  - Product Details – product attributes, dimensions, surface materials and functionality
  - Product Application – vertical and horizontal planning guidelines including support and load, power, and storage
  - Technical Specifications – provides performance ratings, material composition and manufacturing process information
- 7 Finishes, Fabrics and COM**
  - Lists information for material finishes and availability.
  - Provides COM information and requirements (if applicable).
- 8 North American Terms of Sale**
  - Haworth terms for ordering, pricing, shipping and delivery, general terms, and services.
- 9 Index**
  - Products are listed alphabetically by alpha-numeric catalog numbers with price list page number.
- 10 Product Non-Obsolescence and Warranty Policy**
  - Provides information about the Haworth policy for non-obsolescence and warranty.

## Additional Information and Resources

Prices are subject to change without notice or approval. Haworth dealers should always submit proposals through Lynx before presenting to customers. See North American Terms of Sale for more information.

### Online Resources

#### haworth.com

- Haworth's corporate website provides access to price books and a variety of other resources and publications.

#### surfaces.haworth.com

- Website provides access to the most current fabrics and finishes offered across Haworth's various product lines.

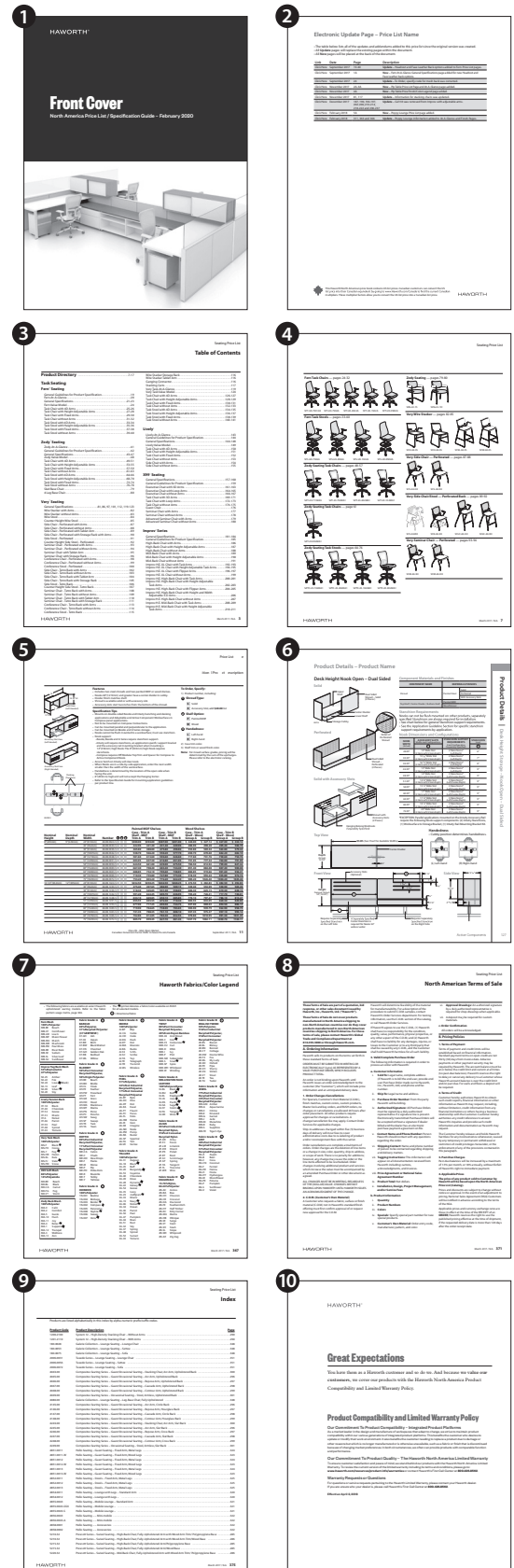

# Table of Contents

---

<b>At-A-Glance</b> .....	5
<b>Statement of Line</b> .....	6-7
<b>Plume Screens</b>	
Plume 3 .....	8
Plume 6 .....	8
Plume 9 .....	8
<b>Feather Sofa</b>	
Feather – Symmetrical .....	9
Feather – Asymmetrical .....	9
<b>Chick Pouf</b>	
Chick Pouf with Back .....	10
Chick Pouf without Back .....	10
Large Square - No Back .....	11
Rectangle - No Back .....	11
Round - No Back .....	12
<b>Sprig Tables</b>	
Rectangle .....	13
Round .....	13
<b>Desk</b>	
Single Desk .....	14
Double Desk .....	15
Privacy Desk .....	16
<b>Booth</b>	
Single Booth .....	17
Corner Booth .....	18
Privacy Booth .....	19
Conference Booth .....	20
Double Booth .....	21
<b>Height Adjustable Table</b> .....	22
<b>Accessories</b>	
Coat Hook .....	23
Soft Storage .....	23
Pillows .....	23
<b>Hideaway Power Module</b> .....	24
<b>Bezel Utility Module</b> .....	25
<b>Finishes and Fabrics</b>	
Finish/Color Legend .....	62
Fabrics/Color Legends .....	63-65
<b>Terms of Sale</b>	
North America .....	66-69
<b>Index</b> .....	70
<b>Lifetime Product Warranty</b> .....	Inside Back Cover

# At-A-Glance

**Designer** Patricia Urquiola - Studio Urquiola

**Awards/Achievements** NeoCon 2014 - Best of Competition - Collaborative Collections  
NeoCon 2014 - Best of NeoCon Gold - Collaborative Collections

**Plume Screen**

- Available:
  - Plume 3 - (1) screen 57"H, (1) screen 65"H, (1) screen 61"H
  - Plume 6 - (6) screens all 57"H (shown)
  - Plume 9 - (9) screens all 57"H
- Screens always connect

**Feather Sofa**

- Available: Symmetrical or Asymmetrical (Left Handed Asymmetrical shown)
- With or without attached table
- Specifiable top stitch
- Fabric always applied railroad

**Chick Pouf without Back**  
• Specifiable top stitch

**Chick Pouf with Back**  
• Seat and Inside Back always match  
• Base and Backrest always match  
• Specifiable top stitch

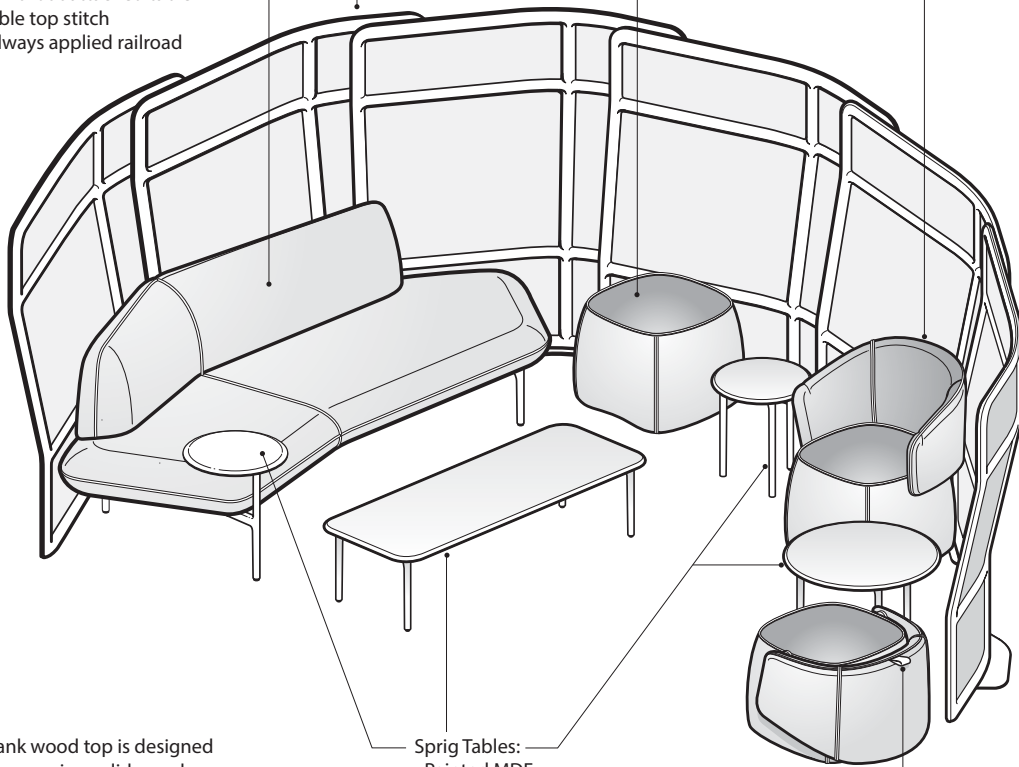

Note - Plank wood top is designed to be unique, using solid wood planks with a clear, low gloss finish allowing visibility of the natural beauty of each wood plank.

- Strig Tables:**
- Painted MDF
  - Plank White Oak
  - Plank Walnut
  - Leg color specified

**Pull Tab**  
• Color not specified, Orange only

# Statement of Line

## Plume Screens — page 8

### Plume 3

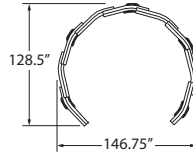
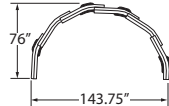
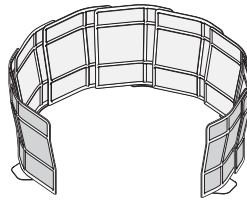
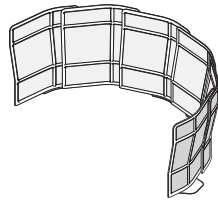
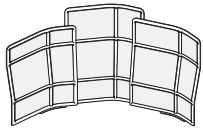

SON-3

SON-6

SON-9

## Feather Sofa — page 9

### Symmetrical

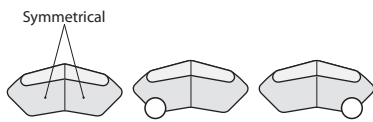
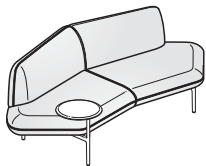

SOSS-1-RW

SOSS-1-N

SOSS-1-RW

SOSS-1-LW

## Asymmetrical – Right Hand — page 9

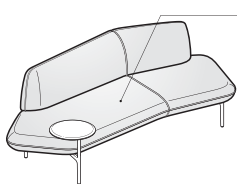

Right Handed (Larger Section At Users Right)

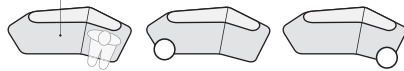

SOSR-1-RW

SOSR-1-N

SOSR-1-RW

SOSR-1-LW

## Asymmetrical – Left Hand — page 9

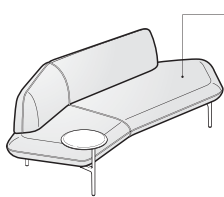

Left Handed (Larger Section At Users Left)

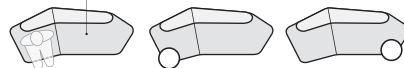

SOSL-1-RW

SOSL-1-N

SOSL-1-RW

SOSL-1-LW

## Chick Pouf — page 10

### With Back

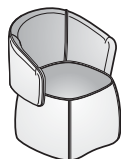

SOPB-22

Outer Surfaces Material Specified: • Always Match  
Inner Surfaces Material Specified: • Always Match

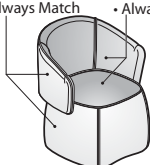

### Without Back



SOPN-22



Puck: Color Specified



Thread: Color Specified  
Pull Tab: Color Not Specified, Orange Only

# Statement of Line

**Large Square - No Back** — page 11

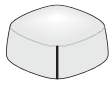

SOPN-2238

**Rectangle - No Back** — page 11

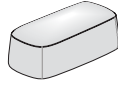

SOPN-2252

**Round - No Back** — page 12



SOPN-2265

**Sprig Tables** — page 13

**Rectangle**

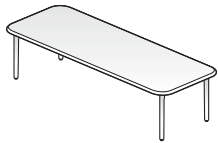

SORA-5320-P

**Round**



SODB-2424-P



SODC-1616-P

**Single Desk** — page 14



HOAS-2

**Double Desk** — page 15

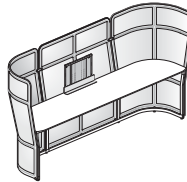

HOAD-3

**Privacy Desk** — page 16

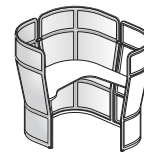

HOAP-3

**Single Booth** — page 17

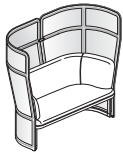

HOAB-2

**Corner Booth** — page 18



HOAC-3

**Privacy Booth** — page 19

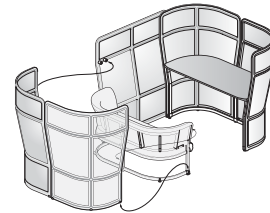

HOAE-5

**Conference Booth** — page 20

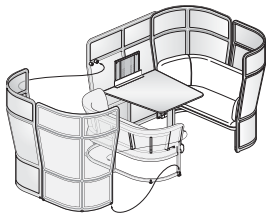

HOAW-5

**Double Booth** — page 21

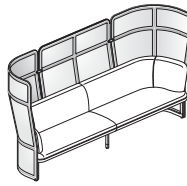

HOA1-3

**Height Adjustable Table** — page 22

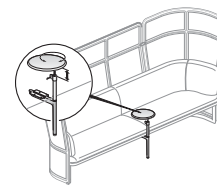

HOUT-1616

**Accessories** — pages 23-25



**Coat Hook**  
HOCH



**Soft Storage**  
HOUS

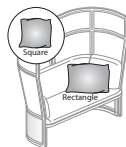

**Pillows**  
HOUP



**Hideaway Power Module**  
HOPD

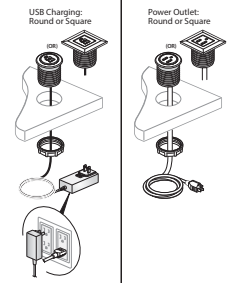

**Bezel Utility Module**  
EURT-0072-1100  
EURT-0072-1010

# Plume Screens

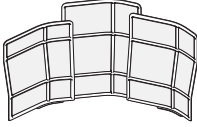
<p><b>Plume 3</b></p>  <p>SON-3</p>	<p><b>Dimensions</b></p> <p>H: 65"(1651mm)                  D: 34.5"(876mm)                  W: 125.75"(3194mm)                  (Outside)                  113.5"(2883mm)                  (Inside)</p>	<p><b>Features</b></p> <ul style="list-style-type: none"> <li>Includes:                         <ul style="list-style-type: none"> <li>(1) 57"(1448mm)H x 50"(1270mm)W screen,</li> <li>(1) 65"(1651mm)H x 50"(1270mm)W screen,</li> <li>(1) 61"(1549mm)H x 50"(1270mm)W screen.</li> </ul> </li> <li>All screens are connected together, not interchangeable.</li> <li>Available in King, Class and Maya fabrics only; COM not available.</li> <li>Floor support and screen connectors in same color.</li> </ul>	<p><b>To Order, Specify:</b></p> <ol style="list-style-type: none"> <li>Product number.</li> <li>Inner material.</li> <li>Outer Material.</li> <li>Trim color.</li> </ol>
---	--	---	---

	Number	Fabric Grade C	D
	SON-3	\$9308.27	\$10740.33

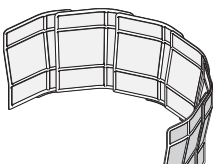
<p><b>Plume 6</b></p>  <p>SON-6</p>	<p><b>Dimensions</b></p> <p>H: 57"(1448mm)                  D: 84"(2134mm)                  W: 143.75"(3651mm)                  (Outside)                  132"(3353mm)                  (Inside)</p>	<p><b>Features</b></p> <ul style="list-style-type: none"> <li>Includes:                         <ul style="list-style-type: none"> <li>(6) 57"(1448mm)H x 50"(1270mm)W screens.</li> </ul> </li> <li>All screens are connected together, not interchangeable.</li> <li>Available in King, Class and Maya fabrics only; COM not available.</li> <li>Floor support and screen connectors in same color.</li> </ul>	<p><b>To Order, Specify:</b></p> <ol style="list-style-type: none"> <li>Product number.</li> <li>Inner material.</li> <li>Outer Material.</li> <li>Trim color.</li> </ol>
---	---	--	---

	SON-6	\$17900.49	\$20287.25
--	-------	------------	------------

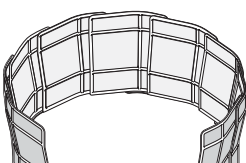
<p><b>Plume 9</b></p>  <p>SON-9</p>	<p><b>Dimensions</b></p> <p>H: 57"(1448mm)                  D: 128.5"(3264mm)                  W: 146.75"(3727mm)                  (Outside)                  131.25"(3334mm)                  (Inside)</p>	<p><b>Features</b></p> <ul style="list-style-type: none"> <li>Includes:                         <ul style="list-style-type: none"> <li>(9) 57"(1448mm)H x 50"(1270mm)W screens.</li> </ul> </li> <li>All screens are connected together, not interchangeable.</li> <li>Available in King, Class and Maya fabrics only; COM not available.</li> <li>Floor support and screen connectors in same color.</li> </ul>	<p><b>To Order, Specify:</b></p> <ol style="list-style-type: none"> <li>Product number.</li> <li>Inner material.</li> <li>Outer Material.</li> <li>Trim color.</li> </ol>
---	---	--	---

	SON-9	\$26850.76	\$29834.18
--	-------	------------	------------

**Note:** For mixed grade fabric surfaces, please refer to the electronic design and specification tools for these prices.

**Note:** The Openest Plume screen is made with polyester fabric adhered to a polyester core. The screen is compliant with UL-1286 flammability requirements and California Technical Bulletin TB-117-2013 requirements. The fabric covering is compliant with NFPA 701 requirements. Consult your local code authority to assure that screens are compliant prior to installation.



# Feather Sofa

## Feather – Symmetrical

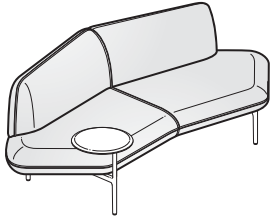

SOSS-1-RW

### Dimensions

#### Sofa

SH: 16.5"(419mm)  
 TH: 30.25"(768mm)  
 SD: 25"(635mm)  
 TD: 37"(940mm)  
 W: 87"(2210mm)

#### Table

H: 19.5"(495mm)  
 D: 15.75"(400mm)

### Features

- Includes: Sofa with specifiable top-stitch thread and optional side mount table.
- Legs: Painted cast aluminum.
- Optional table:
  - Can be right-side or left-side mounted.
  - Rotates 360°
  - Available in Black, Polar, Stormy or Vapor painted MDF or planked wood in White Oak or Walnut.
  - Planked wood tops are designed to be unique, using solid wood planks with a clear, low-gloss finish showing natural variation.
- COM yardage: 6.5

### To Order, Specify:

1) Product number, including:

#### 1 Surface Material:

- 1 Leather
- 2 Fabric
- 3 Faux Leather

#### 2 Table Option:

- N No Table
- R Right Hand Table
- L Left Hand Table

- 2) Surface color.
- 3) Thread color.
- 4) Leg color.
- 5) Table finish (if applicable).

### Specification Tips

- Fabric will be applied railroaded.
- Linear or patterned fabric is not recommended due to the manner in which fabric is applied.

Description	Number 1 2	Fabric Grade		C	D	E	F	G	H	Leather Grade A	Leather Grade B
		A	B								
Without Table	SOSS- -N	\$3580.10	\$3782.97	\$4009.71	\$4176.78	\$4534.79	\$4713.80	\$5101.65	\$5220.99	\$7070.71	\$8502.75
With Painted MDF Table	SOSS- -P	\$4284.19	\$487.06	\$4713.80	\$4880.87	\$5238.88	\$5417.89	\$5805.74	\$5925.08	\$7774.80	\$9206.84
With Wood Table - White Oak	SOSS- -W	\$4952.47	\$5155.34	\$5382.08	\$5549.15	\$5907.16	\$6086.17	\$6474.02	\$6593.36	\$8443.08	\$9875.12
With Wood Table - Walnut	SOSS- -W	\$5041.98	\$5244.85	\$5471.59	\$5638.66	\$5996.67	\$6175.68	\$6563.53	\$6682.87	\$8532.59	\$9964.63

## Feather – Asymmetrical

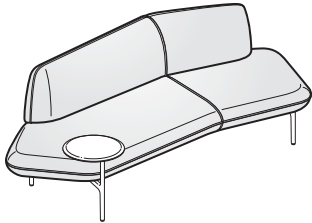

SOSR-1-RW

### Dimensions

#### Sofa

SH: 16.5"(419mm)  
 TH: 30.25"(768mm)  
 SD: 25"(635mm)  
 TD: 37"(940mm)  
 W: 92"(2337mm)

#### Table

H: 19.5"(495mm)  
 D: 15.75"(400mm)

### Features

- Includes: Sofa with specifiable top-stitch thread and optional side mount table.
- Legs: Painted cast aluminum.
- Optional table:
  - Can be right-side or left-side mounted.
  - Rotates 360°
  - Available in Black, Polar, Stormy or Vapor painted MDF or planked wood in White Oak or Walnut.
  - Planked wood tops are designed to be unique, using solid wood planks with a clear, low-gloss finish showing natural variation.
- COM yardage: 6.75

### To Order, Specify:

1) Product number, including:

#### 1 Handedness:

- R Right hand
- L Left hand

#### 2 Surface Material:

- 1 Leather
- 2 Fabric
- 3 Faux Leather

#### 3 Table Option:

- N No Table
- R Right Hand Table
- L Left Hand Table

- 2) Surface color.
- 3) Thread color.
- 4) Leg color.
- 5) Table finish (if applicable).

### Specification Tips

- Fabric will be applied railroaded.
- Linear or patterned fabric is not recommended due to the manner in which fabric is applied.
- Handedness determined when seated on sofa.

Description	Number 1 2 3	Fabric Grade		C	D	E	F	G	H	Leather Grade A	Leather Grade B
		A	B								
Without Table	SOS - -N	\$3639.77	\$3854.58	\$4087.29	\$4325.96	\$4683.97	\$4892.81	\$5310.49	\$5399.99	\$7124.39	\$ 8592.25
With Painted MDF Table	SOS - -P	\$4343.86	\$4558.67	\$4791.38	\$5030.05	\$5388.06	\$5596.90	\$6014.58	\$6104.08	\$7828.48	\$9296.34
With Wood Table - White Oak	SOS - -W	\$5012.14	\$5226.95	\$5459.66	\$5698.33	\$6056.34	\$6265.18	\$6682.86	\$6772.36	\$8496.76	\$9964.62
With Wood Table - Walnut	SOS - -W	\$5101.65	\$5316.46	\$5549.17	\$5787.84	\$6145.85	\$6354.69	\$6772.37	\$6861.87	\$8586.27	\$10054.13

The following options require modification of the product number.

Stain Repellent

To specify, add **P** to the end of the product number; **Example:** SOSS-2-RPP (add \$178.15 list)

For sofa without table add **0P** to the end of the product number. **Example:** SOSS-2-N0P

# Chick Pouf

## Chick Pouf with Back

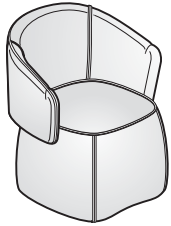

SOPB-2223

### Dimensions

SH: 18"(457mm)  
 TH: 37.75"(959mm)  
 SD: 18.75"(476mm)  
 TD: 25.2"(640mm)  
 W: 26"(660mm)

### Features

- Includes: Seat and back with specifiable top-stitch thread and puck colors.
- Seat back flips up and down.
- Pull tab to flip back up or down available in orange only.
- COM yardage:  
 Inner/Outer surfaces matching: 3.5  
 Inner Back and Seat only: 1.5  
 Outer Back and Base only: 2.0

### Specification Tip

- Linear or patterned fabric is not recommended due to the manner in which fabric is applied.

### To Order, Specify:

- Product number, including:

#### 1 Inner Surface Material:

- Leather
- Fabric
- Faux Leather

#### 2 Outer Surface Material:

- Leather
- Fabric
- Faux Leather

- Inner Surface Color (Seat, inside back).

- Outer Surface Color (Base, outer back).

- Thread color.

- Puck color.

Number 1 2	Fabric Grade		C	D	E	F	G	H	Leather Grade A	Leather Grade B
	A	B								
SOPB-■ ■ 23-00H	\$2088.38	\$2207.72	\$2368.84	\$2518.00	\$2756.68	\$2882.00	\$3162.40	\$3251.92	\$3938.14	\$4684.00

## Chick Pouf without Back

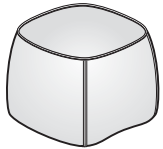

SOPN-2223

### Dimensions

H: 18"(457mm)  
 D: 22.5"(572mm)  
 W: 23.25"(591mm)

### Features

- Includes: Seat/Base only with specifiable top-stitch thread color.
- COM yardage:  
 Seat and Base matching: 2.75  
 Seat only: .75  
 Base only: 2.0

### Specification Tip

- Linear or patterned fabric is not recommended due to the manner in which fabric is applied.

### To Order, Specify:

- Product number, including:

#### 1 Seat Surface Material:

- Leather
- Fabric
- Faux Leather

#### 2 Base Surface Material:

- Leather
- Fabric
- Faux Leather

- Inner Surface Color (Seat).

- Outer Surface Color (Base).

- Thread color.

Number 1 2	Fabric Grade		C	D	E	F	G	H	Leather Grade A	Leather Grade B
	A	B								
SOPN-■ ■ 23-00H	\$1008.40	\$1074.02	\$1175.45	\$1282.87	\$1426.07	\$1508.40	\$1700.54	\$1748.27	\$2326.24	\$2891.91

The following options require modification of the product number.

Stain Repellent

To specify, add **-P** to the end of the product number; **Example:** SOPB-2223-00HP; SOPN-2223-00HP (add **\$89.68** list for Chick Pouf with Back or **\$51.25** for Chick Pouf without Back)

**Note:** For mixed grade fabric surfaces, please refer to the electronic design and specification tools for these prices.

# Chick Pouf

## Large Square - No Back

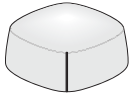

SOPN-2238

### Dimensions

H: 17"(432mm)  
D: 37.75"(959mm)  
W: 37.75"(959mm)

### Features

- Includes: Seat and base with specifiable top-stitch thread around the top and down the corners.
- Available with black hard or felt glides.
- COM yardage:
  - Seat and Base matching: 4.0
  - Seat only: 1.3
  - Base only: 2.6

### Specification Tip

- Fabric will be applied railroaded.
- Linear or patterned fabric is not recommended due to the manner in which fabric is applied.

### To Order, Specify:

1) Product number, including:

#### 1 Seat Surface Material:

- 1 Leather
- 2 Fabric
- 3 Faux Leather

#### 2 Base Surface Material:

- 1 Leather
- 2 Fabric
- 3 Faux Leather

#### 3 Glide Option:

- H Hard Glides
- K Felt Glides

2) Seat surface color.

3) Base surface color.

4) Thread color.

Number 1 2 3	Fabric Grade		C	D	E	F	G	H	Leather Grade A	Leather Grade B
	A	B								
SOPN- 38-00	\$1446.12	\$1542.53	\$1638.93	\$1739.37	\$1831.75	\$2265.59	\$2506.61	\$2940.45	\$2771.20	\$3237.17

## Rectangle - No Back

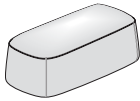

SOPN-2252

### Dimensions

H: 18"(457mm)  
D: 27"(686mm)  
W: 52"(1321mm)

### Features

- Includes: Seat and base with specifiable top-stitch thread around the top and down the corners.
- Available with black hard or felt glides.
- COM yardage:
  - Seat and Base matching: 4.6
  - Seat only: 2.0
  - Base only: 2.6

### Specification Tip

- Fabric will be applied railroaded.
- Linear or patterned fabric is not recommended due to the manner in which fabric is applied.

### To Order, Specify:

1) Product number, including:

#### 1 Seat Surface Material:

- 1 Leather
- 2 Fabric
- 3 Faux Leather

#### 2 Base Surface Material:

- 1 Leather
- 2 Fabric
- 3 Faux Leather

#### 3 Glide Option:

- H Hard Glides
- K Felt Glides

2) Seat surface color.

3) Base surface color.

4) Thread color.

Number 1 2 3	Fabric Grade		C	D	E	F	G	H	Leather Grade A	Leather Grade B
	A	B								
SOPN- 52-00	\$1703.21	\$1815.68	\$1928.16	\$2045.34	\$2153.12	\$2658.72	\$2940.44	\$3446.60	\$3111.84	\$3600.30

The following options require modification of the product number.

Stain Repellent

To specify, add **P** to the end of the product number; **Example:** SOPN-2238-00HP  
(Large Square add **\$73.91** list; Rectangle add **\$86.77** list)

**Note:** For mixed grade fabric surfaces, please refer to the electronic design and specification tools for these prices.

# Chick Pouf

**Round - No Back**

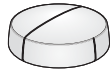

SOPN-2265

**Dimensions**

H: 17"(432mm)  
D: 65"(1651mm)

**Features**

- Includes: Seat and base with specifiable top-stitch thread around the top, across the middle of the top, and four vertical seams (every 90°).
- Available with black hard or felt glides or six black braking casters.
- Braking casters lock into place when weight is loaded on the pouf.
- COM yardage:  
Seat and Base matching: 8.0  
Seat only: 4.0  
Base only: 4.0

**Specification Tip**

- Fabric will be applied railroaded.
- Linear or patterned fabric is not recommended due to the manner in which fabric is applied.

**To Order, Specify:**

1) Product number, including:

**1 Seat Surface Material:**

- 2** Fabric
- 3** Faux Leather

**2 Base Surface Material:**

- 2** Fabric
- 3** Faux Leather

**3 Glide/Caster Option:**

- H** Hard Glides
- K** Felt Glides
- B** Braking Casters (add **\$395.27** list)

- 2) Seat surface color.
- 3) Base surface color.
- 4) Thread color.

Number	Fabric Grade			C	D	E	F	G	H	Leather Grade A	Leather Grade B		
	1	2	3									A	B
SOPN- <span style="background-color: #cccccc;">■</span> <span style="background-color: #cccccc;">■</span> 65-00 <span style="background-color: #cccccc;">■</span>				<b>\$3149.33</b>	<b>\$3342.15</b>	<b>\$3534.97</b>	<b>\$3735.81</b>	<b>\$3920.59</b>	<b>\$4788.27</b>	<b>\$5270.31</b>	<b>\$6137.97</b>	N/A	N/A

The following options require modification of the product number.

Stain Repellent

To specify, add **P** to the end of the product number; **Example:** SOPN-2265-00HP (add **\$147.83** list)

**Note:** For mixed grade fabric surfaces, please refer to the electronic design and specification tools for these prices.

# Sprig Tables

## Rectangle

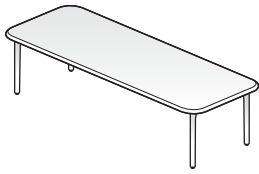

SORA-5320-P

### Features

- Includes: Table top and legs.
- Top available in Black, Polar, Stormy or Vapor painted MDF or planked wood in White Oak or Walnut.
- Planked wood tops are designed to be unique, using solid wood planks with a clear, low-gloss finish showing natural variation.
- Legs: Painted cast aluminum.

### To Order, Specify:

1) Product number, including:

#### ① Surface Material:

- P** Painted MDF
- W** Planked Wood

2) Top color.

3) Leg color.

Height	Depth	Width	Number ①	Painted	White Oak	Walnut
12"(305mm)	20"(508mm)	53"(1346mm)	SORA-5320-■	<b>\$990.50</b>	<b>\$2476.24</b>	<b>\$3013.26</b>

## Round



SODC-1616-P



SODB-2424-P

### Features

- Includes: Table top and legs.
- Top available in Black, Polar, Stormy, or Vapor painted MDF or planked wood in White Oak or Walnut.
- Planked wood tops are designed to be unique, using solid wood planks with a clear, low-gloss finish showing natural variation.
- Legs: Painted cast aluminum.

### To Order, Specify:

1) Product number, including:

#### ① Surface Material:

- P** Painted MDF
- W** Planked Wood

2) Top color.

3) Leg color.

Height	Diameter	Number ①	Painted	White Oak	Walnut
17"(432mm)	16"(406mm)	SODC-1616-■	<b>\$704.09</b>	<b>\$1432.05</b>	<b>\$1551.38</b>
14"(356mm)	24"(610mm)	SODB-2424-■	<b>775.69</b>	<b>1921.32</b>	<b>2207.73</b>

# Single Desk



HOAS-2

### Overall Dimensions

H: 58"(1473mm)  
 D: 28"(711mm)  
 W: 65"(1651mm)

### Features

- Includes: Two screens, one attached worksurface with painted steel structure.
- Worksurface available in painted MDF, laminate or wood veneer.
- Worksurface fixed height 29"(737mm).
- Screens available in King, Class, and Maya fabrics only. COM not available.
- Ships unassembled.

### Specification Tips

- Screens are non-load bearing.
- Not reconfigurable.
- Will not accept monitor arms, keyboard pads or attached or suspended pedestals.
- Screens are not tackable or pinnable.
- Separately specified power or USB module field installed.
- For more detailed dimensions, refer to specification guide.

### To Order, Specify:

1) Product number, including:

#### 1 Surface Material:

- P** Painted MDF
- L** Laminate
- W** Wood

2) Screen inner material.

3) Screen outer material.

4) Desk surface and color.

5) Edgeband color (if applicable).

6) Trim color.

Number 1	Screen Grade C	Laminate Worksurface		Wood Worksurface	
	Painted MDF Worksurface Price	Grade A	Grade B	Grade A	Grade B
HOAS-2-N <span style="background-color: #cccccc; border: 1px solid black; padding: 0 2px;">NNS</span>	\$7878.54	\$7530.96	\$7588.89	\$7936.48	\$7994.40

Number 1	Screen Grade D	Laminate Worksurface		Wood Worksurface	
	Painted MDF Worksurface Price	Grade A	Grade B	Grade A	Grade B
HOAS-2-N <span style="background-color: #cccccc; border: 1px solid black; padding: 0 2px;">NNS</span>	\$8457.84	\$8110.26	\$8168.19	\$8515.78	\$8573.70

**Note:** For mixed grade fabric surfaces, please refer to the electronic design and specification tools for these prices.

**Note:** The Openest screen is made with polyester fabric adhered to a polyester core. The screen is compliant with UL-1286 flammability requirements and California Technical Bulletin TB-117-2013 requirements. The fabric covering is compliant with NFPA 701 requirements. Consult your local code authority to assure that screens are compliant prior to installation.

# Double Desk

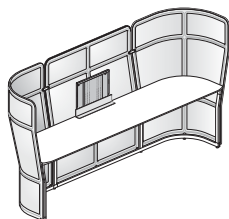

HOAD-3

### Overall Dimensions

H: 58"(1473mm)  
 D: 28"(711mm)  
 W: 117"(2972mm)

### Features

- Includes: Three screens, one attached worksurface with painted steel structure and monitor mount (if applicable).
- Worksurface available in painted MDF, laminate or wood veneer.
- Worksurface fixed height 29"(737mm).
- Monitor mount accepts 40"(1016mm)-42"(1067mm) monitors.
- Screens available in King, Class, and Maya fabrics only. COM not available.
- Monitor mount.
  - Table mounting bracket mounts unit to worksurface and supports monitor in a viewing position. Standard in black.
  - Front and rear trim match trim specification and hides cables and wires behind the monitor.
- Ships unassembled.

### Specification Tips

- Not reconfigurable.
- Soft Storage cannot be used on the Double Desk.
- Coat Hook not to be used with mounted monitor.
- Will not accept monitor arms, keyboard pads or attached or suspended pedestals.
- Screens are not tackable or pinnable.
- Separately specified power or USB module field installed.
- For more detailed dimensions, refer to specification guide.

### To Order, Specify:

1) Product number, including:

#### 1 Surface Material:

- P** Painted MDF
- L** Laminate
- W** Wood

#### 2 Monitor Mount:

- N** No Monitor Mount
- M** Monitor Mount, add **\$1158.61** list

- 2) Screen inner material.
- 3) Screen outer material.
- 4) Desk surface and color.
- 5) Edgeband color (if applicable).
- 6) Trim color.

Number 1 2	Screen Grade C	Laminate Worksurface		Wood Worksurface	
	Painted MDF Worksurface Price	Grade A	Grade B	Grade A	Grade B
HOAD-3-N ■ ■ NS	\$11817.82	\$11238.52	\$11354.38	\$11875.76	\$11991.62

Number 1 2	Screen Grade D	Laminate Worksurface		Wood Worksurface	
	Painted MDF Worksurface Price	Grade A	Grade B	Grade A	Grade B
HOAD-3-N ■ ■ NS	\$12628.86	\$12049.56	\$12165.42	\$12686.80	\$12802.66

**Note:** For mixed grade fabric surfaces, please refer to the electronic design and specification tools for these prices.

**Note:** The Openest screen is made with polyester fabric adhered to a polyester core. The screen is compliant with UL-1286 flammability requirements and California Technical Bulletin TB-117-2013 requirements. The fabric covering is compliant with NFPA 701 requirements. Consult your local code authority to assure that screens are compliant prior to installation.

# Privacy Desk

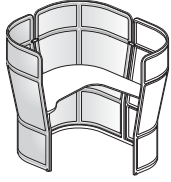

HOAP-3  
(Right-hand shown)

### Dimensions

H: 58"(1473mm)  
D: 65"(1651mm)  
W: 55"(1397mm)

### Features

- Includes: Three screens, one attached worksurface and steel structure.
- Worksurface available in painted MDF, laminate or wood veneer.
- Worksurface fixed height 29"(737mm).
- Screens available in King, Class, and Maya fabrics only. COM not available.
- Painted steel structure.
- Ships unassembled.

### Specification Tips

- Screens are non-load bearing.
- Not reconfigurable.
- Will not accept monitor arms, keyboard pads or attached or suspended pedestals.
- Screens are not tackable or pinnable.
- Separately specified power or USB module field installed.
- Handedness determined by return location.
- For more detailed dimensions, refer to specification guide.

### To Order, Specify:

1) Product number, including:

#### 1 Surface Material:

- P** Painted MDF
- L** Laminate
- W** Wood

#### 2 Handedness:

- R** Right-Hand
- L** Left-Hand

- 2) Screen inner material.
- 3) Screen outer material.
- 4) Desk surface and color.
- 5) Edgeband color (if applicable).
- 6) Trim color.

Number 1 2	Screen Grade C Painted MDF Worksurface Price	Laminate Worksurface		Wood Worksurface	
		Grade A	Grade B	Grade A	Grade B
HOAP-3-N <input type="checkbox"/> N <input type="checkbox"/> S	\$11470.24	\$11006.80	\$11093.69	\$11528.17	\$11615.08

Number 1 2	Screen Grade D Painted MDF Worksurface Price	Laminate Worksurface		Wood Worksurface	
		Grade A	Grade B	Grade A	Grade B
HOAP-3-N <input type="checkbox"/> N <input type="checkbox"/> S	\$12281.28	\$11817.84	\$11904.73	\$12339.21	\$12426.12

**Note:** For mixed grade fabric surfaces, please refer to the electronic design and specification tools for these prices.

**Note:** The Openest screen is made with polyester fabric adhered to a polyester core. The screen is compliant with UL-1286 flammability requirements and California Technical Bulletin TB-117-2013 requirements. The fabric covering is compliant with NFPA 701 requirements. Consult your local code authority to assure that screens are compliant prior to installation.



# Single Booth

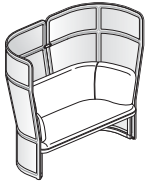

HOAB-2

**Dimensions:**

- SH: 18"(457mm)
- H: 58"(1473mm)
- SD: 20"(508mm)
- TD: 30"(762mm)
- SW: 44"(1118mm)
- TW: 65"(1651mm)

**Features**

- Includes: Two screens, one attached sofa with specifiable top-stitch thread and painted steel structure.
- Screens available in King, Class, and Maya fabrics only. COM not available.
- Ships unassembled.
- COM yardage/sq. footage (sofa): 3.25 / 58.5

**Specification Tips**

- Screens are non-load bearing.
- Not reconfigurable.
- Screens are not tackable or pinnable.
- Sofa accepts separately specified and field installed Hideaway Power Module.
- Sofa fabric applied railroaded.
- Linear or patterned fabric not recommended due to the manner in which fabric is applied.
- For more detailed dimensions, refer to specification guide.

**To Order, Specify:**

1) Product number, including:

**1 Seat Surface Material:**

- 1** Leather
- 2** Fabric
- 3** Faux Leather

- 2) Screen inner material.
- 3) Screen outer material.
- 4) Sofa material and color.
- 5) Thread color.
- 6) Trim color.

Number 1	Screen Grade C								Leather Grade A	Leather Grade B
	Seat Grade		A	B	C	D	E	F		
HOAB-2- ■ NNNN	\$9558.54	\$9732.33	\$9761.30	\$9848.19	\$9964.06	\$10050.95	\$10253.71	\$10317.43	\$11875.76	\$12455.06

Number 1	Screen Grade D								Leather Grade A	Leather Grade B
	Seat Grade		A	B	C	D	E	F		
HOAB-2- ■ NNNN	\$10137.84	\$10311.63	\$10340.60	\$10427.49	\$10543.36	\$10630.25	\$10833.01	\$10896.73	\$12455.06	\$13034.36

The following options require modification of the product number.

Stain Repellent

To specify, add **P** to the end of the product number; **Example:** HOAB-2-2NNNNP (add **\$83.27** list)

**Note:** For mixed grade fabric surfaces, please refer to the electronic design and specification tools for these prices.

**Note:** The Openest screen is made with polyester fabric adhered to a polyester core. The screen is compliant with UL-1286 flammability requirements and California Technical Bulletin TB-117-2013 requirements. The fabric covering is compliant with NFPA 701 requirements. Consult your local code authority to assure that screens are compliant prior to installation.

# Corner Booth

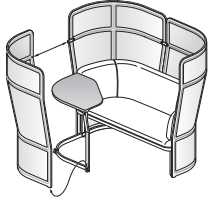

HOAC-3  
(Right-hand shown)

### Dimensions:

SH: 18"(457mm)  
H: 58"(1473mm)  
SD: 20"(508mm)  
TD: 55"(1397mm)  
SW: 44"(1118mm)  
TW: 65"(1651mm)

### Worksurface Dimensions:

H: 29"(737mm)  
D: 24"(610mm)  
W: 29"(737mm)

### Features

- Corner Booth must be **ordered as two individual items**:
  - Item 1 includes: Three screens, one attached sofa with specifiable top-stitch thread and painted steel structure.
  - Item 2 includes: Corner worksurface.
- Screens available in King, Class, and Maya fabrics only. COM not available.
- Worksurface available in painted MDF, laminate or wood veneer.
- Worksurface fixed height is 29"(737mm).
- Ships unassembled.
- COM yardage/sq. footage (sofa): 3.25 / 58.5

### Specification Tips

- Screens are non-load bearing.
- Will not accept monitor arms, keyboard pads or attached or suspended pedestals.
- Not reconfigurable.
- Screens are not tackable or pinnable.
- Separately specified power or USB module field installed.
- Sofa accepts separately specified and field installed Hideaway Power Module.
- Handedness determined from a seated position.
- Sofa fabric applied railroaded.
- Linear or patterned fabric not recommended due to the manner in which fabric is applied.
- For more detailed dimensions, refer to specification guide.

### To Order, Specify:

#### ITEM #1

1) Product number, including:

#### 1 Seat Surface Material:

- 1 Leather
- 2 Fabric
- 3 Faux Leather

#### 2 Handedness:

- R Right-Hand
- L Left-Hand

- 2) Screen inner material.
- 3) Screen outer material.
- 4) Sofa surface and color.
- 5) Thread color.
- 6) Trim color.

### To Order, Specify:

#### ITEM #2

1) Product number, including:

#### 1 Surface Material:

- P Painted MDF
- L Laminate
- W Wood

#### 2 Handedness:

- R Right-Hand
- L Left-Hand

- 2) Surface and color.
- 3) Edgeband color (if applicable).

### ITEM #1 – Screens and Sofa

Number 1 2	Screen Grade C								Leather Grade A	Leather Grade B
	Seat Grade									
	A	B	C	D	E	F	G	H		
HOAC-3- NN N	\$12744.71	\$12918.50	\$12947.47	\$13034.36	\$13150.23	\$13237.12	\$13439.88	\$13503.60	\$15061.93	\$15641.23

Number 1 2	Screen Grade D								Leather Grade A	Leather Grade B
	Seat Grade									
	A	B	C	D	E	F	G	H		
HOAC-3- NN N	\$13555.75	\$13729.54	\$13758.51	\$13845.40	\$13961.27	\$14048.16	\$14250.92	\$14314.64	\$15872.97	\$16452.27

### ITEM #2 – Worksurface

Number 1 2	Painted MDF Worksurface		Laminate Worksurface		Wood Worksurface	
	Price		Grade A	Grade B	Grade A	Grade B
HOAC-W-N N S	\$666.20		\$434.48	\$475.04	\$666.20	\$724.13

The following options require modification of the product number.

Stain Repellent

To specify, add **P** to the end of the product number; **Example:** HOAC-3-2NNRNP (add **\$83.27** list)

**Note:** For mixed grade fabric surfaces, please refer to the electronic design and specification tools for these prices.

**Note:** The Openest screen is made with polyester fabric adhered to a polyester core. The screen is compliant with UL-1286 flammability requirements and California Technical Bulletin TB-117-2013 requirements. The fabric covering is compliant with NFPA 701 requirements. Consult your local code authority to assure that screens are compliant prior to installation.

# Privacy Booth

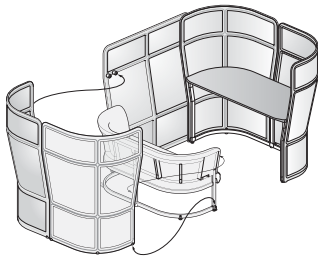

HOAE-5  
(Left-hand shown)

**Dimensions:**

- SH: 18"(457mm)
- H: 58"(1473mm)
- SD: 20"(508mm)
- TD: 67"(1702mm)
- SW: 44"(1118mm)
- TW: 94"(2388mm)

**Worksurface Dimensions:**

- H: 29"(737mm)
- D: 25"(635mm)
- W: 57"(1448mm)

**Features**

- Privacy Booth must be **ordered as two individual items**:
  - Item 1 includes: Five screens, one attached sofa with specifiable top-stitch thread and painted steel structure.
  - Item 2 includes: Worksurface.
- Screens available in King, Class, and Maya fabrics only. COM not available.
- Worksurface available in painted MDF, laminate or wood veneer.
- Worksurface fixed height is 29"(737mm).
- Open space between the sofa and worksurface is 42"(1067mm).
- Ships unassembled.
- COM yardage/sq. footage (sofa): 3.25 / 58.5

**Specification Tips**

- Screens are non-load bearing.
- Not reconfigurable.
- Handedness determined by sofa side.
- Will not accept monitor arms, keyboard pads or attached or suspended pedestals.
- Screens are not tackable or pinnable.
- Separately specified power or USB module field installed.
- Sofa accepts separately specified and field installed Hideaway Power Module.
- Sofa fabric applied railroaded.
- Linear or patterned fabric not recommended due to the manner in which fabric is applied.
- For more detailed dimensions, refer to specification guide.

**To Order, Specify:**

ITEM #1

1) Product number, including:

**1 Seat Surface Material:**

- 1** Leather
- 2** Fabric
- 3** Faux Leather

**2 Handedness:**

- R** Right-Hand
- L** Left-Hand

- 2) Screen inner material.
- 3) Screen outer material.
- 4) Sofa surface and color.
- 5) Thread color.
- 6) Trim color.

**To Order, Specify:**

ITEM #2

1) Product number, including:

**1 Surface Material:**

- P** Painted MDF
- L** Laminate
- W** Wood

- 2) Surface and color.
- 3) Edgeband color (if applicable).

**ITEM #1 – Screens and Sofa**

Number <b>1</b> <b>2</b>	Screen Grade C Seat Grade								Leather Grade A	Leather Grade B
	A	B	C	D	E	F	G	H		
HOAE-5- <input type="checkbox"/> NN <input type="checkbox"/> N	\$18248.11	\$18421.90	\$18450.87	\$18537.76	\$18653.63	\$18740.52	\$18943.28	\$19007.00	\$20565.33	\$21144.63

Number <b>1</b> <b>2</b>	Screen Grade D Seat Grade								Leather Grade A	Leather Grade B
	A	B	C	D	E	F	G	H		
HOAE-5- <input type="checkbox"/> NN <input type="checkbox"/> N	\$19290.85	\$19464.64	\$19493.61	\$19580.50	\$19696.37	\$19783.26	\$19986.02	\$20049.74	\$21608.07	\$22187.37

**ITEM #2 – Worksurface**

Number <b>1</b>	Painted MDF Worksurface Price	Laminate Worksurface Grade A	Laminate Worksurface Grade B	Wood Worksurface Grade A	Wood Worksurface Grade B
	HOAE-W-N <input type="checkbox"/> NNS	\$897.92	\$550.34	\$608.27	\$955.86

The following options require modification of the product number.

Stain Repellent

To specify, add **P** to the end of the product number; **Example:** HOAE-5-2NNRNP (add **\$83.27** list)

**Note:** For mixed grade fabric surfaces, please refer to the electronic design and specification tools for these prices.

**Note:** The Openest screen is made with polyester fabric adhered to a polyester core. The screen is compliant with UL-1286 flammability requirements and California Technical Bulletin TB-117-2013 requirements. The fabric covering is compliant with NFPA 701 requirements. Consult your local code authority to assure that screens are compliant prior to installation.

# Conference Booth

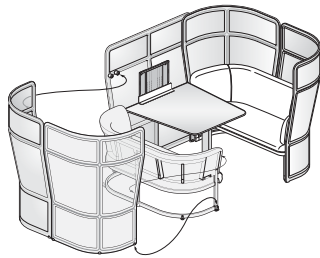

HOAW-5  
(shown with monitor mount)

### Dimensions:

SH: 18"(457mm)  
H: 58"(1473mm)  
SD: 20"(508mm)  
TD: 67"(1702mm)  
SW: 44"(1118mm)  
TW: 94"(2388mm)

### Worksurface Dimensions:

H: 29"(737mm)  
D: 46"(1168mm)  
W: 40"(1016mm)

### Features

- Conference Booth must be **ordered as two individual items**:
  - Item 1 includes: Five screens, two attached sofas with specifiable top-stitch thread and painted steel structure.
  - Item 2 includes: Worksurface and monitor mount (if specified).
- Screens available in King, Class, and Maya fabrics only. COM not available.
- Worksurface available in painted MDF, laminate or wood veneer.
- Worksurface fixed height is 29"(737mm).
- Monitor mount accepts 30"(762mm)-32"(813mm) monitor only.
  - Table mounting bracket mounts unit to worksurface and supports monitor in a viewing position. Standard in black.
  - Front and rear trim match trim specification and hides cables and wires behind the monitor.
- Ships unassembled.
- COM yardage/sq. footage (sofa): 3.25 / 58.5

### Specification Tips

- Not reconfigurable.
- Will not accept monitor arms, keyboard pads or attached or suspended pedestals.
- Screens are not tackable or pinnable.
- Separately specified power or USB module field installed.
- Sofa accepts separately specified and field installed Hideaway Power Module.
- Sofa fabric applied railroaded.
- Linear or patterned fabric not recommended due to the manner in which fabric is applied.
- For more detailed dimensions, refer to specification guide.

### To Order, Specify:

#### ITEM #1

- 1) Product number, including:

#### 1 Seat Surface Material:

- 1 Leather
- 2 Fabric
- 3 Faux Leather

- 2) Screen inner material.
- 3) Screen outer material.
- 4) Sofa surface and color.
- 5) Thread color.
- 6) Trim color.

### To Order, Specify:

#### ITEM #2

- 1) Product number, including:

#### 1 Surface Material:

- P Painted MDF
- L Laminate
- W Wood

#### 2 Monitor Mount:

- N No Monitor Mount
- M Monitor Mount, add \$1158.61 list

- 2) Surface and color.
- 3) Edgeband color (if applicable).
- 4) Trim color.

## ITEM #1 – Screens and Sofa

Number 1	Screen Grade C								Leather Grade A	Leather Grade B
	Seat Grade									
	A	B	C	D	E	F	G	H		
HOAW-5-NNNN	\$22824.62	\$23172.20	\$23230.14	\$23403.92	\$23635.64	\$23809.44	\$24214.95	\$24342.41	\$27459.06	\$28617.67

Number 1	Screen Grade D								Leather Grade A	Leather Grade B
	Seat Grade									
	A	B	C	D	E	F	G	H		
HOAW-5-NNNN	\$23867.36	\$24214.94	\$24272.88	\$24446.66	\$24678.38	\$24852.18	\$25257.69	\$25385.15	\$28501.80	\$29660.41

## ITEM #2 – Worksurface

Number 1 2	Painted MDF Worksurface		Laminate Worksurface		Wood Worksurface	
	Price		Grade A	Grade B	Grade A	Grade B
HOAW-W-N NS	\$1013.78		\$550.34	\$637.23	\$1071.71	\$1158.62

The following options require modification of the product number.

Stain Repellent

To specify, add **P** to the end of the product number; **Example:** HOAW-5-2NNNNP (add \$166.55 list)

**Note:** For mixed grade fabric surfaces, please refer to the electronic design and specification tools for these prices.

**Note:** The Openest screen is made with polyester fabric adhered to a polyester core. The screen is compliant with UL-1286 flammability requirements and California Technical Bulletin TB-117-2013 requirements. The fabric covering is compliant with NFPA 701 requirements. Consult your local code authority to assure that screens are compliant prior to installation.

# Double Booth

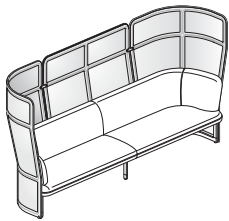

HOA1-3

**Dimensions:**

- SH: 18"(457mm)
- H: 58"(1473mm)
- SD: 20"(508mm)
- TD: 30"(762mm)
- SW: 96"(2438mm)
- TW: 108"(2743mm)

**Features**

- Includes: Three screens, attached double sofa with specifiable top-stitch thread and painted steel structure. Double sofa shipped in two pieces.
- Screens available in King, Class, and Maya fabrics only. COM not available.
- Ships unassembled.
- COM yardage/sq. footage (sofa): 6 / 108

**Specification Tips**

- Screens are non-load bearing.
- Not reconfigurable.
- Screens are not tackable or pinnable.
- Separately specified Hideaway Power Module field installed.
- Sofa fabric applied railroaded.
- For more detailed dimensions, refer to specification guide.

**To Order, Specify:**

1) Product number, including:

**1 Seat Surface Material:**

- 1** Leather
- 2** Fabric
- 3** Faux Leather

- 2) Screen inner material.
- 3) Screen outer material.
- 4) Sofa surface and color.
- 5) Thread color.
- 6) Trim color.
- 7) Table color/finish (if applicable).

Description	Number <b>1</b>	Screen Grade C Seat Grade								Leather Grade A	Leather Grade B
		A	B	C	D	E	F	G	H		
No Table	HOA1-3-NNNN	\$17958.45	\$18306.03	\$18363.97	\$18537.75	\$18769.47	\$18943.27	\$19348.78	\$19476.24	\$22592.89	\$23751.50
Painted Table	HOA1-3-PNHN	18920.10	19267.68	19325.62	19499.40	19731.12	19904.92	20310.43	20437.89	23554.54	24713.15
White Oak Table	HOA1-3-WNHN	20600.08	20947.66	21005.60	21179.38	21411.10	21584.90	21990.41	22117.87	25234.52	26393.13
Walnut Table	HOA1-3-WNHN	20808.63	21156.21	21214.15	21387.93	21619.65	21793.45	22198.96	22326.42	25443.07	26601.68

Description	Number <b>1</b>	Screen Grade D Seat Grade								Leather Grade A	Leather Grade B
		A	B	C	D	E	F	G	H		
No Table	HOA1-3-NNNN	\$18769.49	\$19117.07	\$19175.01	\$19348.79	\$19580.51	\$19754.31	\$20159.82	\$20287.28	\$23403.93	\$24562.54
Painted Table	HOA1-3-PNHN	19731.14	20078.72	20136.66	20310.44	20542.16	20715.96	21121.47	21248.93	24365.58	25524.19
White Oak Table	HOA1-3-WNHN	21411.12	21758.70	21816.64	21990.42	22222.14	22395.94	22801.45	22928.91	26045.56	27204.17
Walnut Table	HOA1-3-WNHN	21619.67	21967.25	22025.19	22198.97	22430.69	22604.49	23010.00	23137.46	26254.11	27412.72

The following options require modification of the product number.

Stain Repellent

To specify, add **P** to the end of the product number; **Example:** HOA1-3-2NNNNP (add \$153.74 list)

**Note:** For mixed grade fabric surfaces, please refer to the electronic design and specification tools for these prices.

**Note:** The Openest screen is made with polyester fabric adhered to a polyester core. The screen is compliant with UL-1286 flammability requirements and California Technical Bulletin TB-117-2013 requirements. The fabric covering is compliant with NFPA 701 requirements. Consult your local code authority to assure that screens are compliant prior to installation.

# Height Adjustable Table

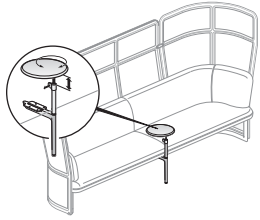

HOUT-1616

### Dimensions

H: 20-24"(508-610mm)  
 D: 16"(406mm)  
 W: 16"(406mm)

### Features

- Includes: Table top and height adjustable leg.
- Top available in painted MDF or plank wood.
- Planked wood tops are designed to be unique, using solid wood planks with a clear, low-gloss finish showing natural variation.
- Legs: Painted cast aluminum.
- Top rotates 360°.
- Height adjustment range is 4"(102mm).

### Specification Tip

- For use on all Openest sofas.

### To Order, Specify:

1) Product number, including:

#### 1 Sofa Type:

**B** Booth

**F** Feather

#### 2 Surface Material:

**P** Painted MDF

**W** Planked Wood

2) Surface and color.

3) Trim color.

### Number 1 2

HOUT-1616-■ ■

### Painted

\$1074.03

### Wood White Oak

\$1813.92

### Walnut

\$2028.73

# Accessories

### Coat Hook

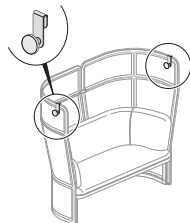

HOCH

#### Dimensions:

H: 7.7"(196mm)  
D: 1.6"(41mm)  
W: 3"(76mm)

#### Features

- Includes: One white oak coat hook.
- Painted steel bracket with white oak wood surface.
- Maximum weight load is 10 lbs.

#### To Order, Specify:

- 1) Product number.
- 2) Trim color.

#### Specification Tips

- Can be used on Plume screens.
- Cannot be hung on the backside of Double Desk with monitor mount.

### Number

HOCH-0000

### Price

\$179.00

### Soft Storage

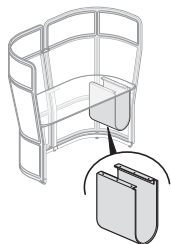

HOUS

#### Dimensions:

H: 12"(305mm)  
D: 16"(406mm)  
W: 8.5"(216mm)

#### Features

- Includes: One soft storage unit with attachment hardware.
- Maximum weight capacity is 30 lbs.
- Available in Big Arrow fabric only. COM not available.

#### To Order, Specify:

- 1) Product number.
- 2) Fabric color.

#### Specification Tips

- Can be used on worksurfaces 16"(406mm) or deeper.
- Not for use on sofas.
- Not for use on Double Desk.

### Number

HOUS-0000

### Price

\$298.34

### Pillows

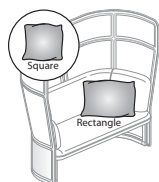

HOUP

#### Features

- Includes: One pillow with 100% polyester fill.
- Available in square or rectangle.
- COM yardage: 0.75

#### To Order, Specify:

- 1) Product number.
- 2) Fabric color.

Description	Height	Width	Number	Fabric Grade							
				A	B	C	D	E	F	G	H
Square	18"(457mm)	18"(457mm)	HOUP-S	\$184.97	\$389.05	\$408.12	\$427.22	\$446.31	\$502.33	\$633.00	\$674.06
Rectangle	16"(406mm)	20"(508mm)	HOUP-R	184.97	389.05	408.12	427.22	446.31	502.33	633.00	674.06

The following options require modification of the product number.

Stain Repellent

To specify, add **-P** to the end of the product number; **Example:** HOUP-S-P (add \$19.22 list)

# Hideaway Power Module

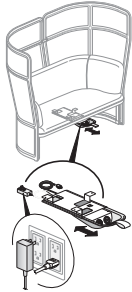

HOPD

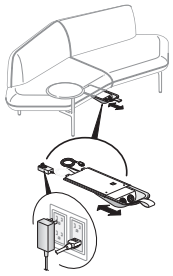

## Features

- Includes: Power drawer, soft drawer pull, power and/or USB ports and mounting hardware.
- Power options include: One power port and one USB port, two power ports, or two USB ports.
- UL listed power outlet provides one NEMA 5-15R outlet.
- USB outlet consists of two USB outlets with 1000mA of charging per USB outlet powered from UL listed transformer.
- Can be used on Openest booth sofa or Feather sofa.
- Mounts to under structure of sofa.
- Tray slides 6”(152mm) forward.
- Drawer available in supplier white only.
- Drawer pull in orange only.

## To Order, Specify:

- 1) Product number, including:  
(No finish specification required.)

### 1 Sofa Type:

- B** Booth
- F** Feather

## Specification Tips

- For use with 120 volt 60 hertz power source only.
- Drawer has one cord with plug (NEMA 5-15P) and one cord with 2”(51mm) x 1”(25mm) x 3”(76mm) voltage transformer plug. Transformer may block adjacent outlets (see illustration).
- Cord reach is 30”(762mm) from back of hideaway power module.
- Requires field installation.
- Application may require approval of local authority having jurisdiction (AHJ); ensure compliance before placing orders and installing.

Description	Height	Depth	Width	Number 1	Price
1 Power, 1 USB Port	3.2”(81mm)	15.5”(394mm)	9.2”(234mm)	HOPD-0006- 11100	<b>\$799.55</b>
2 Power Ports				HOPD-0006- 12000	<b>739.89</b>
2 USB Ports				HOPD-0006- 10200	<b>966.63</b>



# Bezel Utility Module

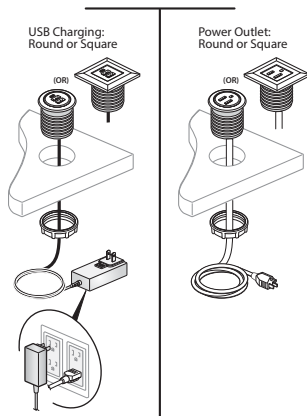

EURT-0072-1100  
EURT-0072-1010



### Features

- Includes: Either a round or square faced Power Module and mounting hardware.
- For use on surfaces 0.75"(19mm) - 1.44"(37mm) thick.
- Available with either:
  - One power outlet (NEMA 5-15R)
  - One two port USB charger. Consists of two USB outlets with 1000mA of charging power (5 volts) per USB outlet.
- Available in black or supplier white only.

### Specification Tips

- For use with 120 volt 60 hertz power source only.
- Power configuration has one cord with plug (NEMA 5-15P).
- USB configuration has one cord with 2"(51mm) x 1"(25mm) x 3"(76mm) voltage transformer plug. Transformer may block adjacent outlets (see illustration).
- Requires field cut 1.75"(44mm) hole and field installation.
- Application may require approval of local authority having jurisdiction (AHJ); ensure compliance before placing orders and installing.

### To Order, Specify:

1) Product number, including:

#### 1 Shape:

- S** Square
- C** Round

#### 2 Color Options:

- B** Black
- W** White

Description	Height	Depth	Width	Number	1 2	Price
<b>6' Cord</b>						
Power		1.75"(44mm)		EURT-0072-1100	■ ■	\$ 84.30
USB				EURT-0072-1010	■ ■	252.92
<b>12' Cord</b>						
Power		1.75"(44mm)		EURT-00E4-1100	■ ■	\$144.52
USB				EURT-00E4-1010	■ ■	313.14

### Data Bezel

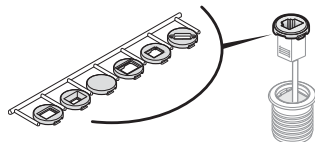

EURT-0000-N001CB  
EURT-0000-N001CW

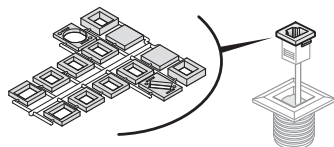

EURT-0000-N001SB  
EURT-0000-N001SW

Description	Number	Price
<b>Round</b>		
Black	EURT-0000-N001CB	\$84.30
White	EURT-0000-N001CW	84.30
<b>Square</b>		
Black	EURT-0000-N001SB	\$84.30
White	EURT-0000-N001SW	84.30

### Feature

- Includes one round or square bezel for the Bezel Utility Module.
- Available in black or supplier white only.

### To Order, Specify:

1) Product number.  
(No finish specification required.)

This page intentionally blank

# Specification Guide – Openest Collection

# Table of Contents – Openest Collection Specification Guide

## Product Details – Openest Collection

- Overview .....30
- Plume Screens .....31
- Feather Sofa .....32
- Chick Pouf .....33
- Sprig Table.....36
- Single Desk .....37
- Double Desk .....38
- Privacy Desk .....39
- Single Booth .....40
- Corner Booth .....41
- Privacy Booth .....42
- Conference Booth .....43
- Double Booth .....44
- Height Adjustable Table .....45
- Accessories – Coat Hook, Soft Storage and Pillows .....46
- Power Components
  - Hideaway Power Module.....47
  - Bezel Utility Module .....48
- Worksurface Edge Details.....49

## Product Application – Openest Collection

- Tips and Tricks
  - Collaborative Spaces .....52
  - Thinking Spaces .....53
  - Touchdown Spaces .....54
  - Social Spaces .....55

## Technical Specifications – Openest Collection

- Technical Specifications.....58

# Product Details – Openest Collection

# Product Details – Openest Collection

## Overview

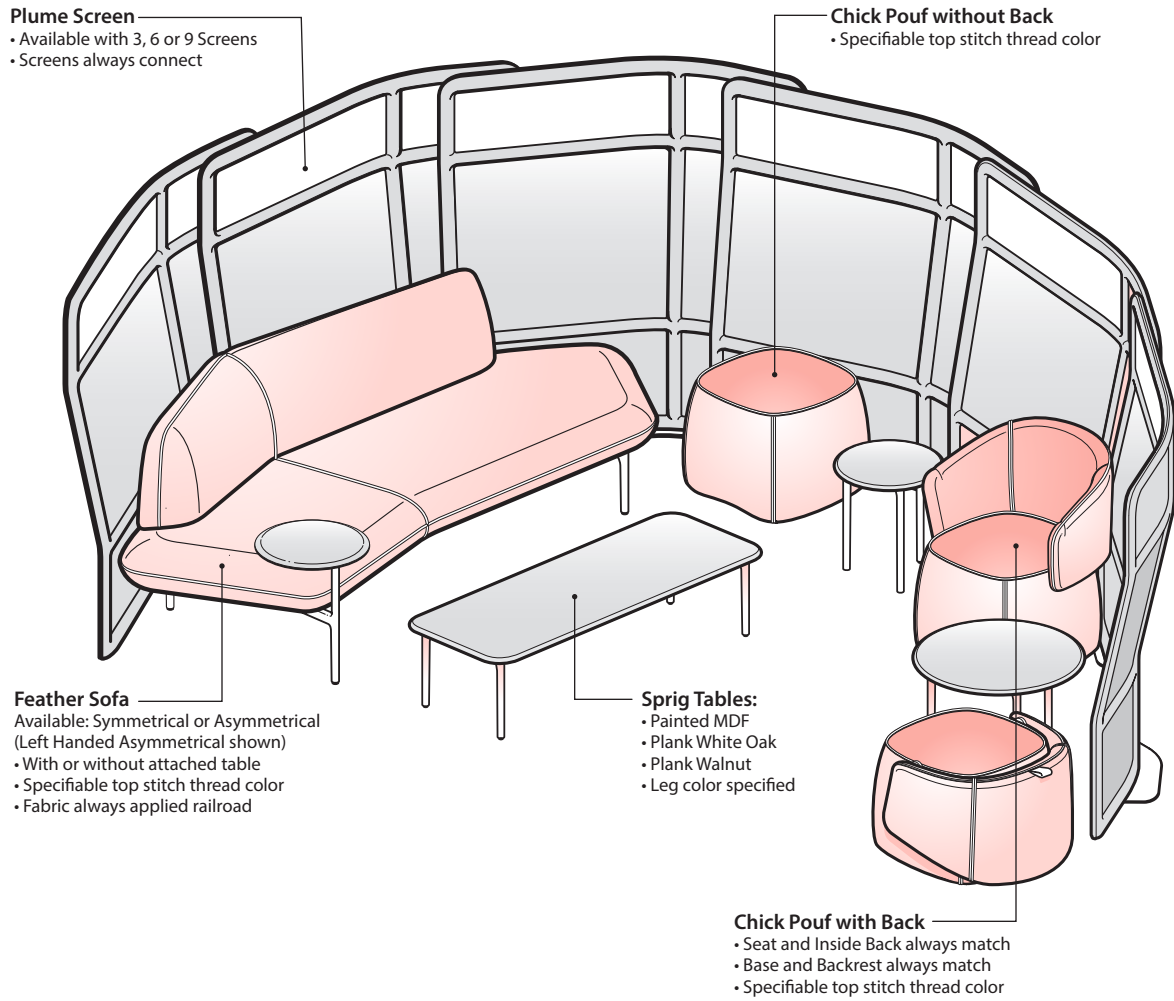

**Note** • For all available height, width and functional configurations refer to the price list for product offerings.

# Product Details – Openest Collection

## Plume Screens

- Freestanding unit includes floor support, screen connectors and are available with three, six or nine screens.
- Different fabric may be specified for inner and outer screen.
- Screens are not load bearing, tackable or reconfigurable.

### Plume 3

- Includes three screens – each screen is 50" wide with variable heights.

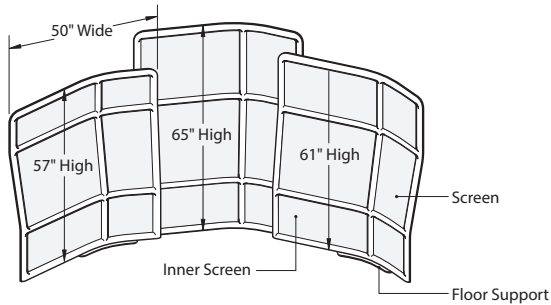

## Component Materials/Finishes

COMPONENT NAME	MATERIALS/ FINISHES
Floor Support and Screen Connectors	Painted Metal – Same as trim Color
Screens	<ul style="list-style-type: none"> <li>• Screen is constructed of fabric adhered to a polyester shell.</li> <li>• Available in King, Class and Maya fabrics only.</li> <li>• Different fabric may be specified for inner and outer screen.</li> </ul>

Top View

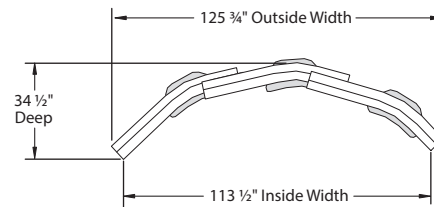

### Plume 6

- Includes six screens – each screen is 57" high and 50" wide.

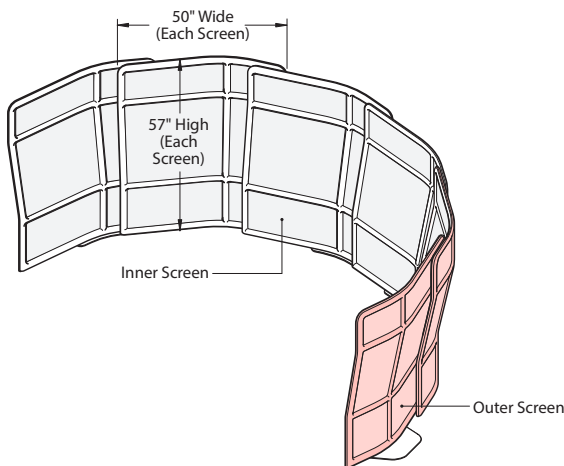

Top View

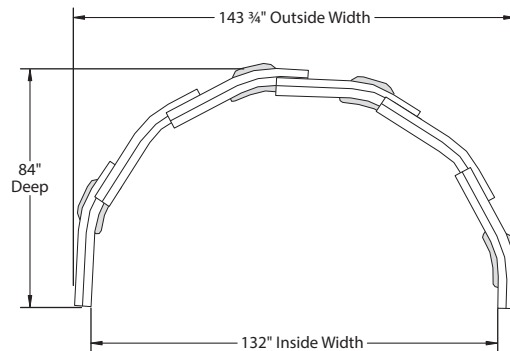

### Plume 9

- Includes nine screens – each screen is 57" high and 50" wide.

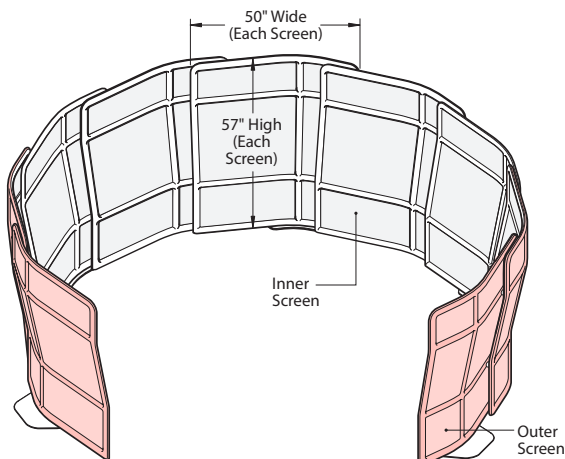

Top View

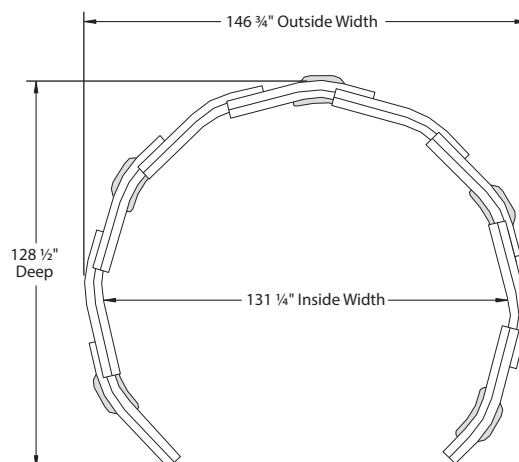

## Product Details – Openest Collection

### Feather Sofa

- Includes: Asymmetrical or Symmetrical Sofa with specifiable top-stitch thread color and optional side mount table.
- Optional side mount table may be attached on the right-side or left-side of the sofa and can rotate 360°.

### Component Materials/Finishes

COMPONENT NAME	MATERIALS/ FINISHES	
Legs	Painted Cast Aluminum	
Sofa Seat and Back	(1) Leather	<ul style="list-style-type: none"> <li>• Top-stitch thread is specifiable</li> <li>• Fabric will be applied railroaded</li> <li>• COM yardage: 6.5</li> <li>• Linear or patterned fabric is not recommended due to the manner in which fabric is applied.</li> </ul>
	(2) Fabric	
	(3) Faux Leather	
Side Mount Table (Optional)	Painted MDF	<ul style="list-style-type: none"> <li>• Available in Black, Polar, Stormy or Vapor.</li> <li>• Wood tops are designed to be unique, using solid wood planks with a clear, low-gloss finish showing natural variation.</li> </ul>
	Plank White Oak	
	Plank Walnut	

### Symmetrical

- Top seam is centered on the sofa and both sides are symmetrical.

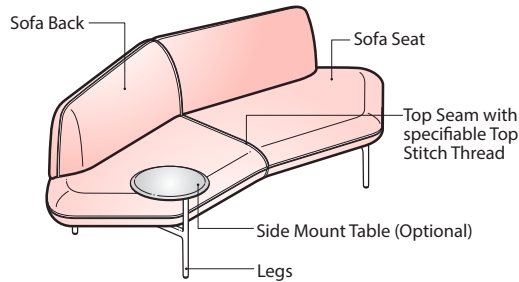

#### Top View

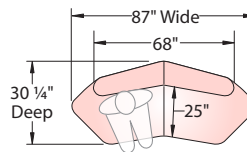

Table Option:  
(N) No Table

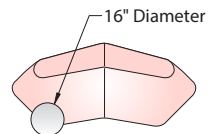

Table Option:  
(R) Right Hand Table

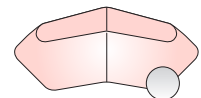
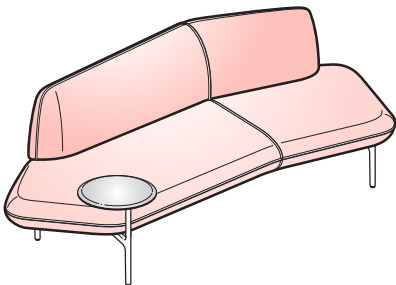

Table Option:  
(L) Left Hand Table

### Asymmetrical – Right Handed

- Top seam is offset from the center making the sofa asymmetrical, with the seated user's right hand side larger than the left hand side.



#### Top View

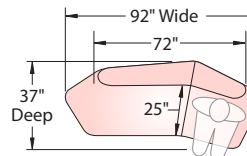

Table Option:  
(N) No Table

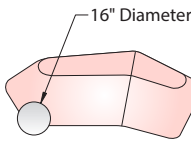

Table Option:  
(R) Right Hand Table

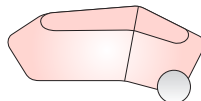
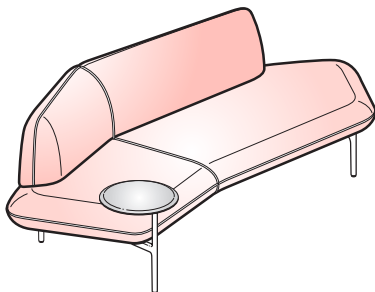

Table Option:  
(L) Left Hand Table

### Asymmetrical – Left Handed

- Top seam is offset from the center making the sofa asymmetrical, with the seated user's left hand side larger than the right hand side.



#### Top View

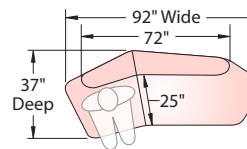

Table Option:  
(N) No Table

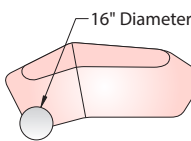

Table Option:  
(R) Right Hand Table

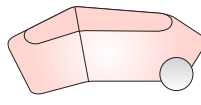
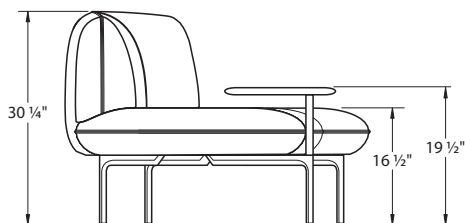

Table Option:  
(L) Left Hand Table

### Dimensions – Side View



### Power Options

- A separately specified Hideaway Power Module may be field installed under the sofa.

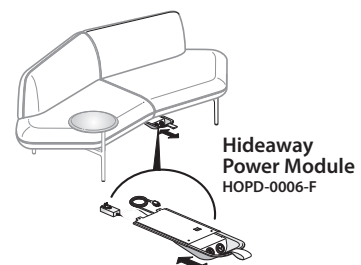



# Product Details – Openest Collection

## Chick Pouf

- Available with a back that flips down or without a back.

### With Back

- Includes seat and back that flips up and down.
- The inner and outer surfaces are specified separately. Top stitch thread color is specified.

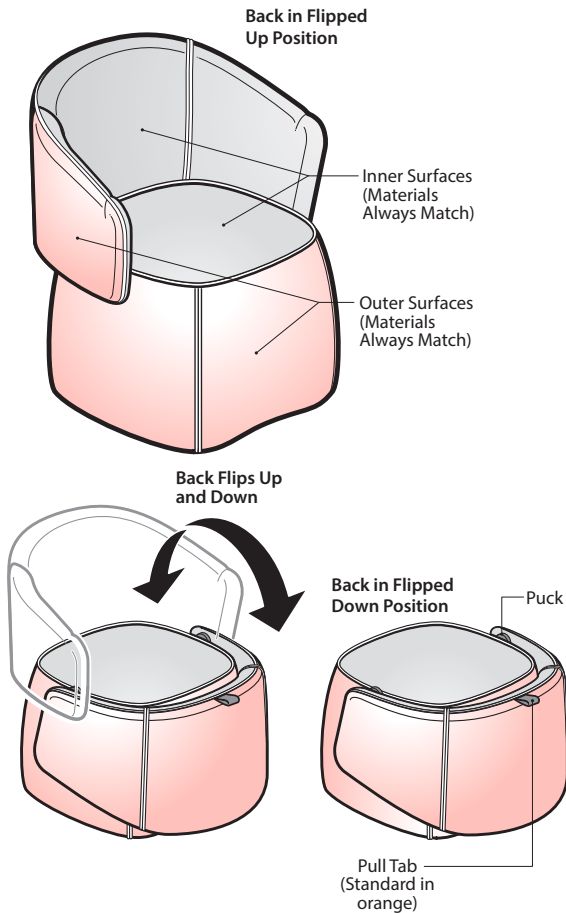

### Component Materials/Finishes

COMPONENT NAME	MATERIALS/ FINISHES	
Seat and Back with ABS bottom closeout with glides	(1) Leather	<ul style="list-style-type: none"> <li>• Top-stitch thread is specifiable.</li> <li>• Material for inner and outer surfaces may specified the same or different.</li> <li>• COM yardage: Inner/Outer surfaces matching: 3.5 Inner Back and Seat only: 1.5 Outer Back and Base only: 2.0</li> </ul>
	(2) Fabric	
	(3) Faux Leather	
Puck	<ul style="list-style-type: none"> <li>• Painted Metal – matches trim color</li> </ul>	
Pull Tab	<ul style="list-style-type: none"> <li>• Polypropylene Strap</li> <li>• Standard with orange color only.</li> </ul>	

### Dimensions Side View

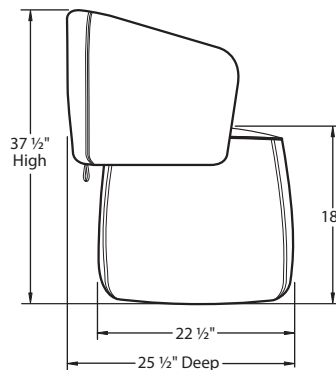

### Front View

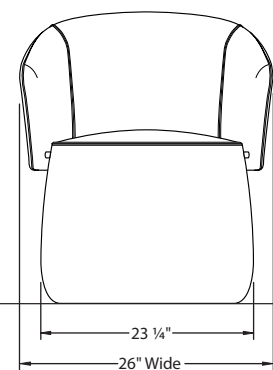

### Without Back

- Includes Seat without a back.

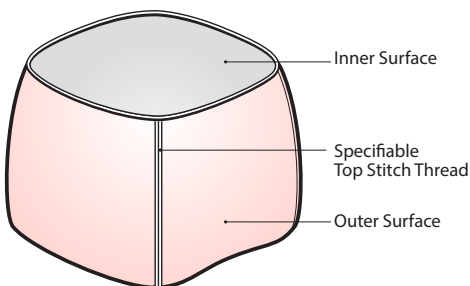

### Component Materials/Finishes

COMPONENT NAME	MATERIALS/ FINISHES	
Seat with ABS bottom closeout with glides	(1) Leather	<ul style="list-style-type: none"> <li>• Top-stitch thread is specifiable.</li> <li>• Material for inner and outer surfaces may specified the same or different.</li> <li>• COM yardage: Inner/Outer surfaces matching: 2.0 Seat only: .75 Base only: 2.0</li> </ul>
	(2) Fabric	
	(3) Faux Leather	

### Dimensions Side View

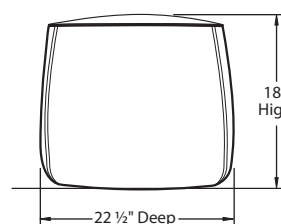

### Front View

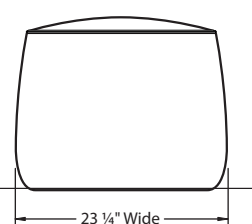

# Product Details – Openest Collection

## Chick Pouf

### Large Square – No Back

- Includes a large square base with no back.
- The surface materials for the seat and base are specified separately.
- Top stitch thread color is specified.

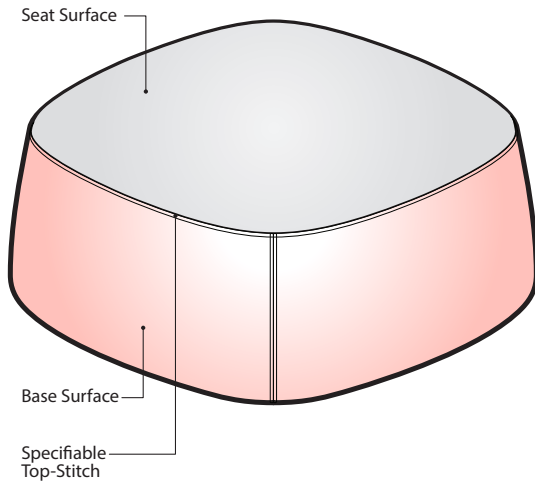

### Component Materials/Finishes

COMPONENT NAME	MATERIALS/ FINISHES	
Seat and Base Surfaces	(1) Leather	<ul style="list-style-type: none"> <li>• Specify material and color for seat and base surfaces, may specified the same or different.</li> <li>• COM Yardage: Seat and Base matching: 4.0</li> <li>Seat only: 1.3</li> <li>Base only: 2.6</li> </ul>
	(2) Fabric	
	(3) Faux Leather	
Top-Stitch	<ul style="list-style-type: none"> <li>• Specify Top-Stitch Thread Color.</li> </ul>	

### Dimensions Top View

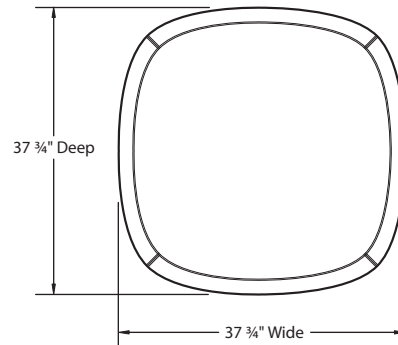

### Front View

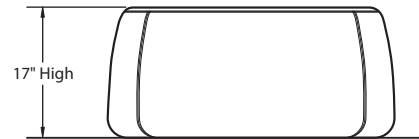

### Rectangle Square – No Back

- Includes a large square base with no back.
- The seat and base surface materials are specified separately. Top stitch thread color is specified.

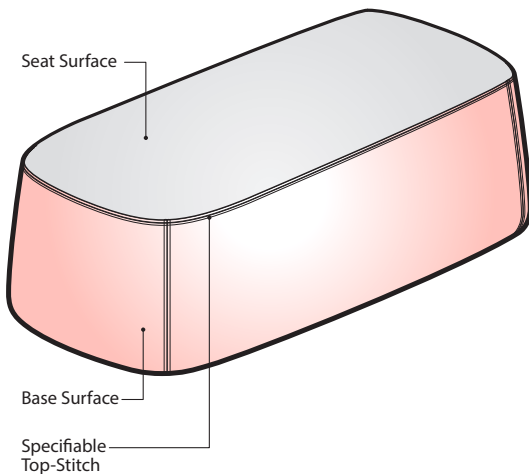

### Component Materials/Finishes

COMPONENT NAME	MATERIALS/ FINISHES	
Seat and Base Surfaces	(1) Leather	<ul style="list-style-type: none"> <li>• Material for seat and base surfaces may specified the same or different.</li> <li>• COM yardage: Seat and Base matching: 4.6</li> <li>Seat only: 2.0</li> <li>Base only: 2.6</li> </ul>
	(2) Fabric	
	(3) Faux Leather	
Top-Stitch	<ul style="list-style-type: none"> <li>• Specify Top-Stitch Thread Color.</li> </ul>	

### Dimensions Top View

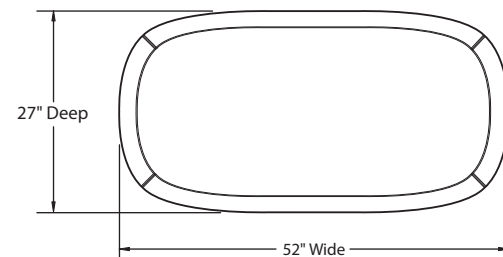

### Front View



# Product Details – Openest Collection

## Chick Pouf

### Large Round – No Back

- Includes a large round base with no back.
- The seat and base surface materials are specified separately. Top stitch thread color is specified.

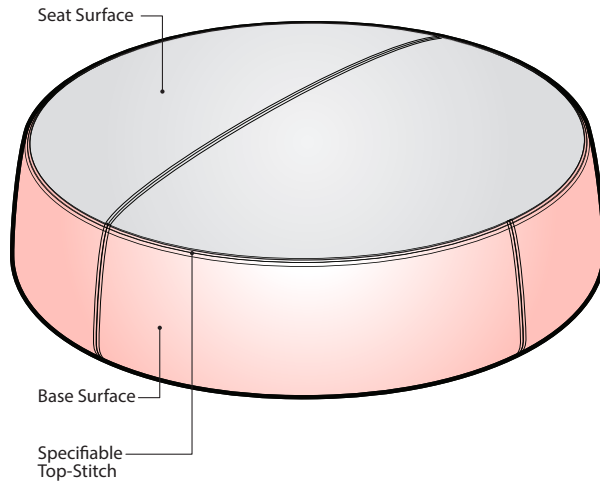

### Component Materials/Finishes

COMPONENT NAME	MATERIALS/ FINISHES
Seat and Base Surfaces	(1) Leather <ul style="list-style-type: none"> <li>• Top-stitch thread is specifiable.</li> <li>• Material for seat and base surfaces may specified the same or different.</li> </ul>
	(2) Fabric <ul style="list-style-type: none"> <li>• COM yardage: Seat and Base matching: 8.0</li> </ul>
	(3) Faux Leather <ul style="list-style-type: none"> <li>• COM yardage: Seat only: 4.0 Base only: 4.0</li> </ul>
Top-Stich	<ul style="list-style-type: none"> <li>• Specify Top-Stitch Thread Color.</li> </ul>

### Dimensions Top View

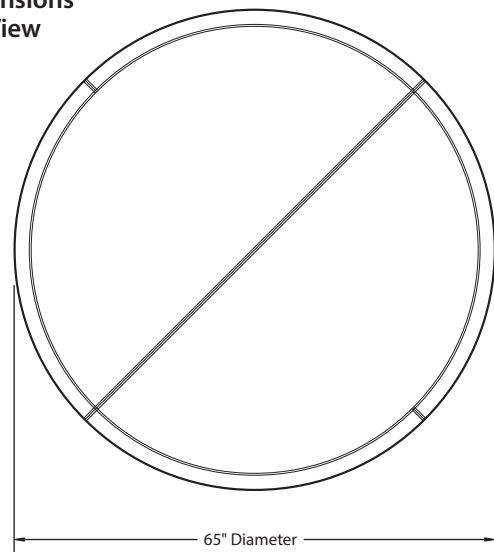

### Front View

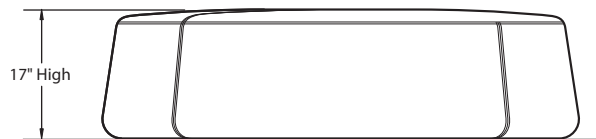

# Product Details – Openest Collection

## Sprig Table

- Includes table top and legs.
- Tops available with wood tops or with painted MDF.

## Component Materials/Finishes

COMPONENT NAME	MATERIALS/ FINISHES	
Legs	Painted Cast Aluminum – matches Trim Color	
Table Top	Painted MDF	• Available in Black, Polar, Stormy or Vapor
	Plank White Oak	• Wood tops are designed to be unique, using solid wood planks with a clear, low-gloss finish showing natural variation.
	Plank Walnut	

### Rectangle Top

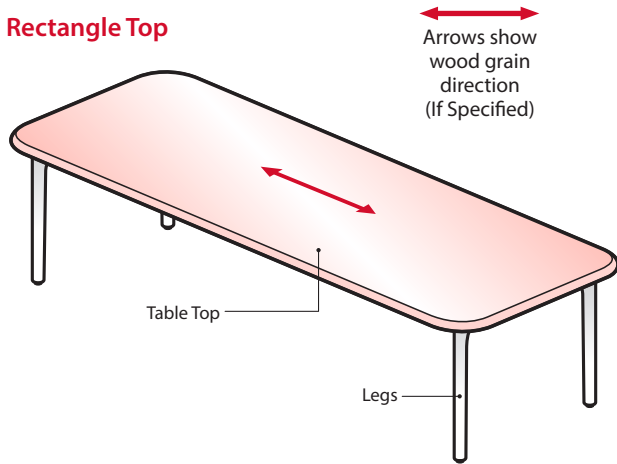

### Dimensions – Top View

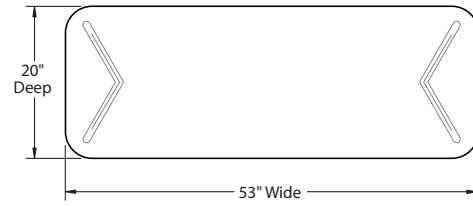

### Front View



### Round Top – 24" Diameter

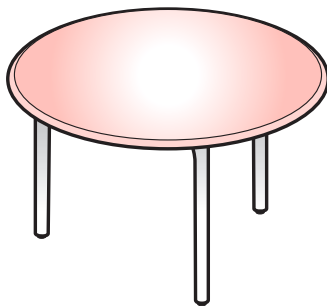

### Dimensions – Top View

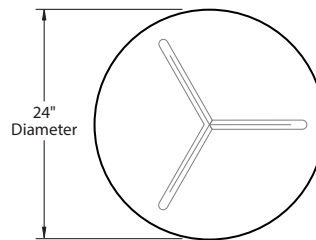

### Front View

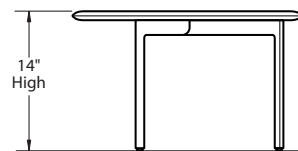

### Round Top – 16" Diameter

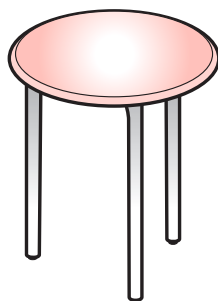

### Dimensions – Top View

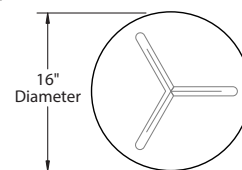

### Front View

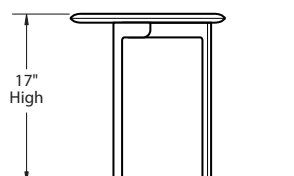

# Product Details – Openest Collection

## Single Desk

- Freestanding unit includes two screens and one attached worksurface with a painted metal support structure.
- Different fabric may be specified for inner and outer screen.
- Screens are not load bearing, tackable or reconfigurable.
- Not for use with monitor arms, adjustable keyboard pads, attached pedestals or suspended pedestals.

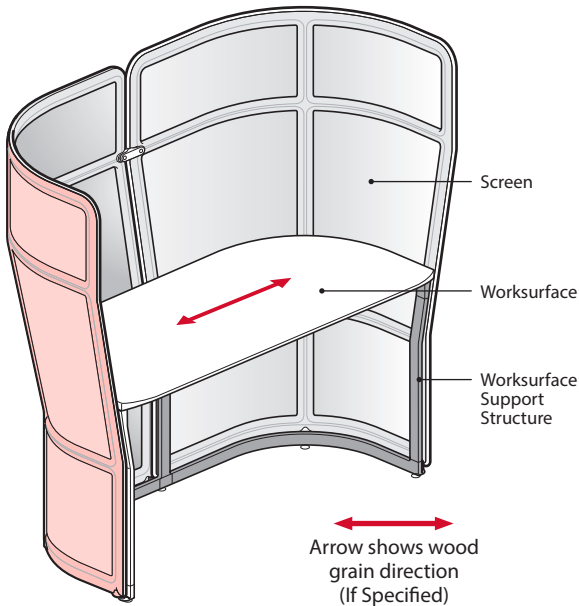

### Dimensions – Top View

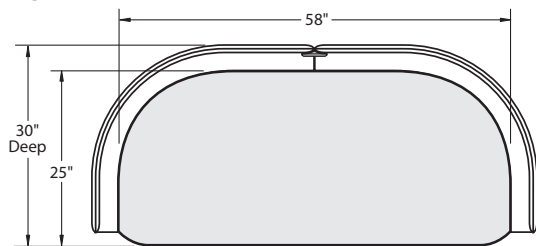

### Front View

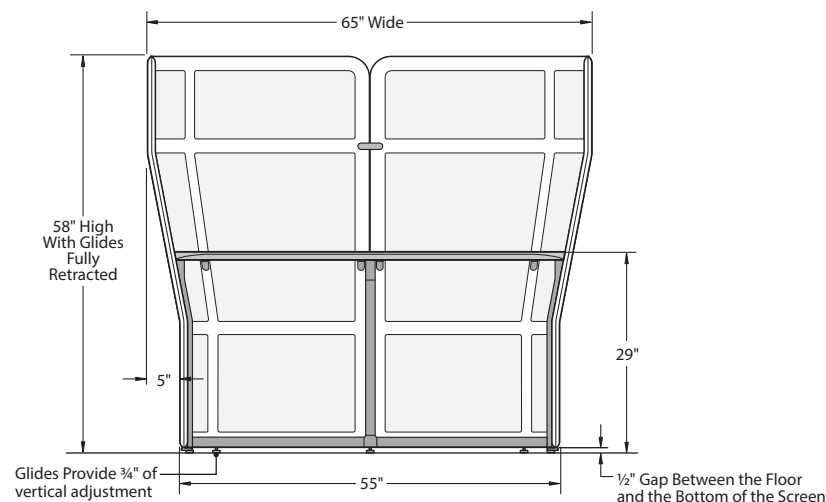

### Component Materials/Finishes

COMPONENT NAME	MATERIALS/ FINISHES	
Screens	<ul style="list-style-type: none"> <li>• Screen is constructed of fabric adhered to a polyester shell.</li> <li>• Available in King, Class and Maya fabrics only.</li> <li>• Different fabric may be specified for inner and outer screen.</li> </ul>	
Worksurface	(P) Painted MDF	Worksurface includes Knife Edge on user side. (See Worksurface Edge Detail Page)
	(L) Laminate	
	(W) Wood Veneer	
Worksurface Support Structure	Painted Metal – Matches Trim Color	

### Power Options

- A separately specified Bezel Utility Module may be field installed on the worksurface.

#### One Power Outlet (NEMA 5-15P)

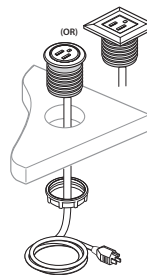

#### Two Port USB Charger

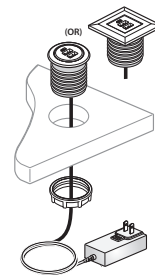

### Accessories

- A separately specified Soft Storage Unit or Coat Hook can be used with this unit.

#### Soft Storage

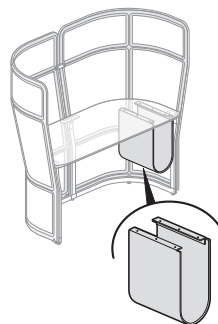

#### Coat Hook

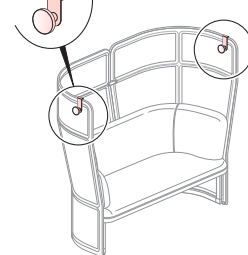

# Product Details – Openest Collection

## Double Desk

- Freestanding unit includes three screens and an attached worksurface with a painted metal support structure. Optional Monitor Mount may be specified.
- Different fabric may be specified for inner and outer screen.
- Screens are not load bearing, tackable or reconfigurable.
- Not for use with monitor arms, adjustable keyboard pads, attached pedestals or suspended pedestals.
- Monitor mount accepts 40"-42" monitors.

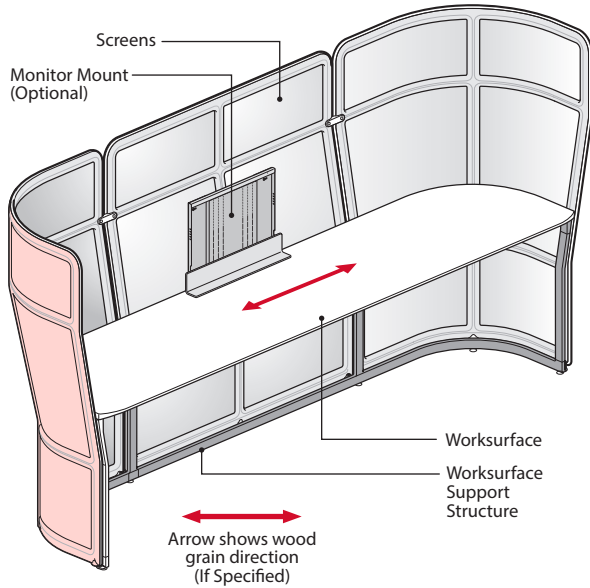

### Dimensions – Top View

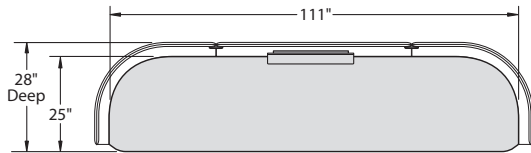

### Front View

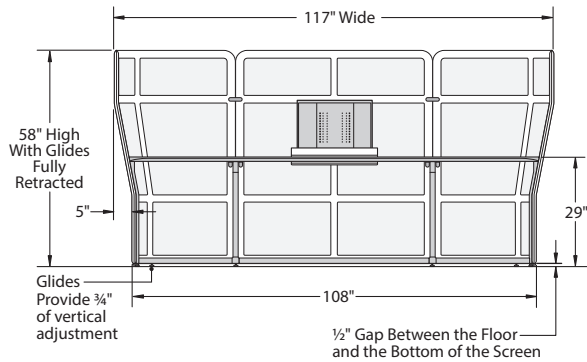

**Note** • The separately specified Coat Hook should not be used with the Double Desk if it is specified with the optional Monitor Mount.

## Component Materials/Finishes

COMPONENT NAME	MATERIALS/ FINISHES	
Screens	<ul style="list-style-type: none"> <li>• Screen is constructed of fabric adhered to a polyester shell.</li> <li>• Available in King, Class and Maya fabrics only.</li> <li>• Different fabric may be specified for inner and outer screen.</li> </ul>	
Worksurface	(P) Painted MDF	Worksurface includes Knife Edge on user side. (See Worksurface Edge Detail Page)
	(L) Laminate	
	(W) Wood Veneer	
Worksurface Support Structure	Painted Metal – Matches Trim Color	
Monitor Mount (Optional)	Table Mounting Bracket	Painted Metal – Standard in Black
	Front and Rear Trim	Painted Metal – Matches Trim Color

## Power Options

- A separately specified Bezel Utility Module may be field installed on the worksurface.

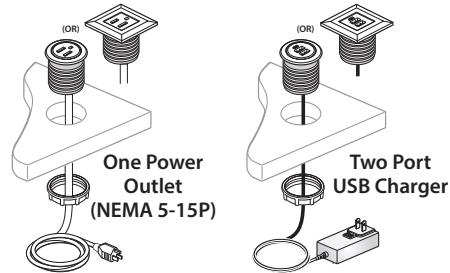

## Accessories



### Soft Storage

- Cannot be used with the Double Desk due to interference with the worksurface under structure.



### Monitor Mount Option

- The optional monitor mount is designed to accommodate most brands of 40" or 42" monitors with centrally located VESA® mounting patterns with widths between 200mm-400mm and heights between 200mm-400mm.
- The monitor and any other mounted equipment such as video conferencing camera may not exceed the 70lbs. maximum load capacity.
- The Monitor can be adjusted vertically in 1/2" increments.

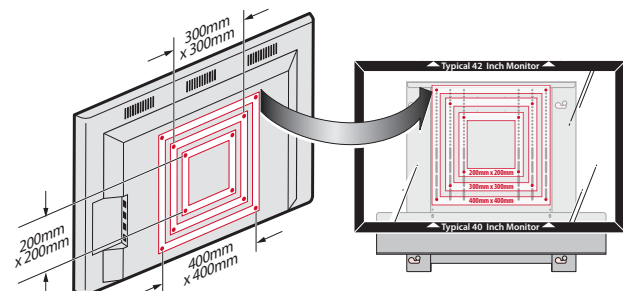

# Product Details – Openest Collection

## Privacy Desk

- Freestanding unit includes three screens and an attached worksurface with a painted metal support structure.
- Different fabric may be specified for inner and outer screen.
- Screens are not load bearing, tackable or reconfigurable.
- Not for use with monitor arms, adjustable keyboard pads, attached pedestals or suspended pedestals.

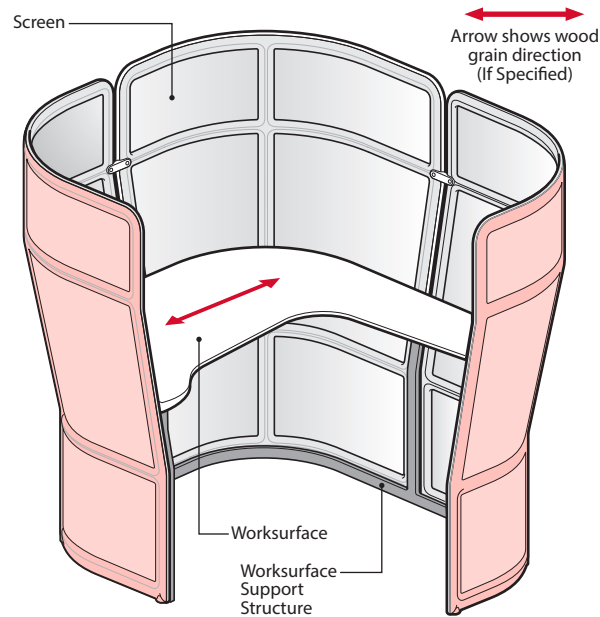

### Component Materials/Finishes

COMPONENT NAME	MATERIALS/ FINISHES	
Screens	<ul style="list-style-type: none"> <li>• Screen is constructed of fabric adhered to a polyester shell.</li> <li>• Available in King, Class and Maya fabrics only.</li> <li>• Different fabric may be specified for inner and outer screen.</li> </ul>	
Worksurface	(P) Painted MDF	Worksurface includes Knife Edge on user side. (See Worksurface Edge Detail Page)
	(L) Laminate	
	(W) Wood Veneer	
Worksurface Support Structure	Painted Metal – Matches Trim Color	

### Power Options

- A separately specified Bezel Utility Module may be field installed on the worksurface.

#### One Power Outlet (NEMA 5-15P)

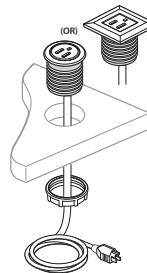

#### Two Port USB Charger

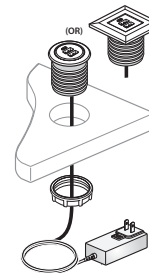

### Accessories

- A separately specified Soft Storage Unit or Coat Hook can be used with this unit.

#### Soft Storage

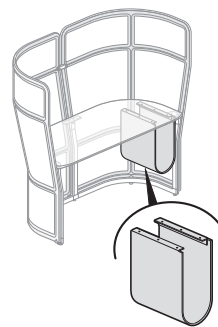

#### Coat Hook

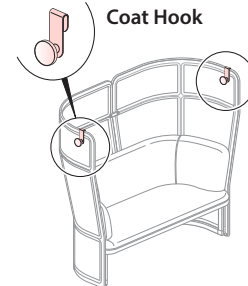

### Dimensions – Top View

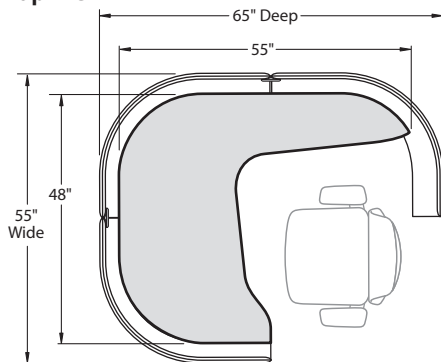

### Front View

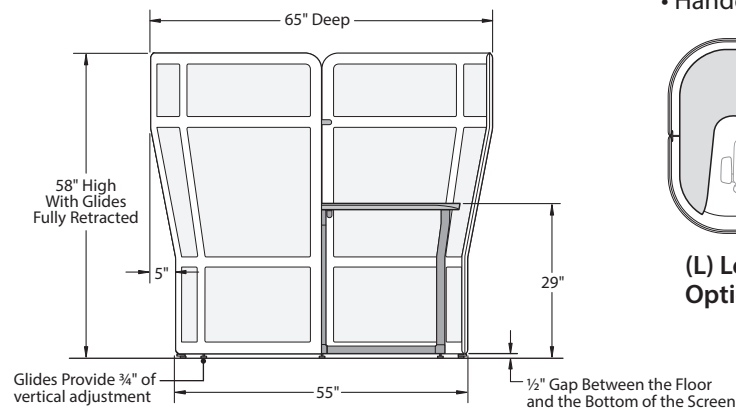

### Orientation Options

- Handedness is determined from a seated position.

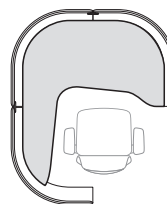

(L) Left Hand Option

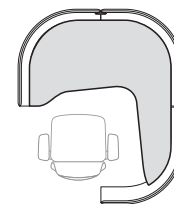

(R) Right Hand Option

## Product Details – Openest Collection

### Single Booth

- Freestanding unit includes two screens and an attached sofa with a painted metal support structure.
- Different fabric may be specified for inner and outer screen.
- The unit is not reconfigurable. Screens are not load bearing, tackable or pinnable.

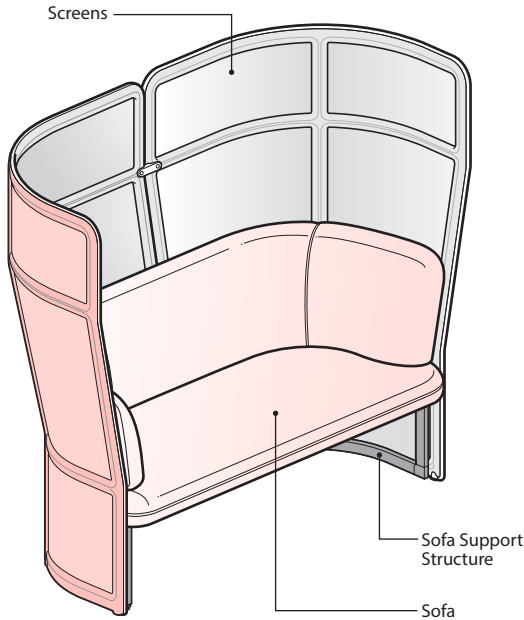

#### Dimensions – Top View

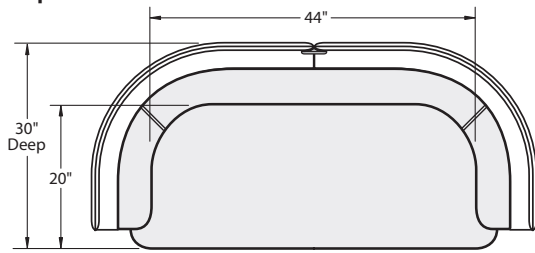

#### Front View

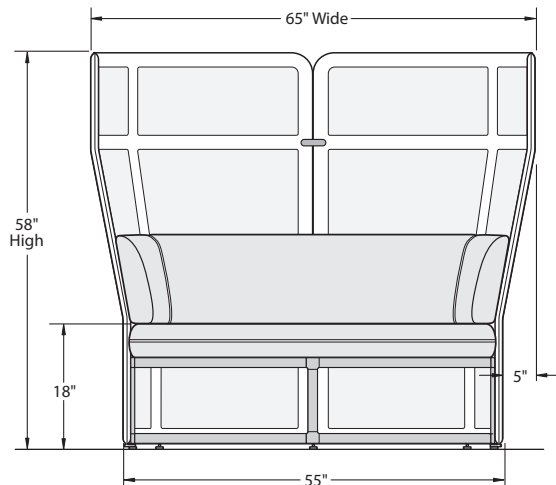

### Component Materials/Finishes

COMPONENT NAME	MATERIALS/ FINISHES				
Screens	<ul style="list-style-type: none"> <li>• Screen is constructed of fabric adhered to a polyester shell.</li> <li>• Available in King, Class and Maya fabrics only.</li> <li>• Different fabric may be specified for inner and outer screen.</li> </ul>				
Sofa	<table border="1"> <tr> <td>(1) Leather</td> <td rowspan="3"> <ul style="list-style-type: none"> <li>• Top-stitch thread color is specifiable.</li> <li>• Sofa fabric applied railroad.</li> <li>• Linear or patterned fabric not recommended due to the manner in which fabric is applied.</li> <li>• COM yardage/ sq. footage: 3.25 / 58.5</li> </ul> </td> </tr> <tr> <td>(2) Fabric</td> </tr> <tr> <td>(3) Faux Leather</td> </tr> </table>	(1) Leather	<ul style="list-style-type: none"> <li>• Top-stitch thread color is specifiable.</li> <li>• Sofa fabric applied railroad.</li> <li>• Linear or patterned fabric not recommended due to the manner in which fabric is applied.</li> <li>• COM yardage/ sq. footage: 3.25 / 58.5</li> </ul>	(2) Fabric	(3) Faux Leather
(1) Leather	<ul style="list-style-type: none"> <li>• Top-stitch thread color is specifiable.</li> <li>• Sofa fabric applied railroad.</li> <li>• Linear or patterned fabric not recommended due to the manner in which fabric is applied.</li> <li>• COM yardage/ sq. footage: 3.25 / 58.5</li> </ul>				
(2) Fabric					
(3) Faux Leather					
Sofa Support Structure	Painted Metal – Matches Trim Color				

### Power Options

- A separately specified Hideaway Power Module may be field installed under the sofa.

#### Hideaway Power Module

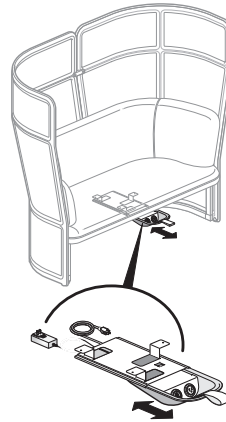

### Accessories

- Separately specified Pillows or Coat Hook can be used with this unit.

#### Pillows

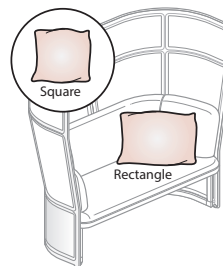

#### Coat Hook

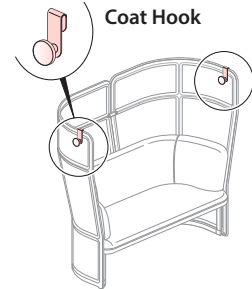



# Product Details – Openest Collection

## Corner Booth

- Corner Booth must be ordered as two individual items:
  - Item 1 includes: Three screens and one attached sofa
  - Item 2 includes: Corner worksurface
- Different fabric may be specified for inner and outer screen.
- Screens are not load bearing, tackable or reconfigurable.
- Not for use with monitor arms, adjustable keyboard pads, attached pedestals or suspended pedestals.

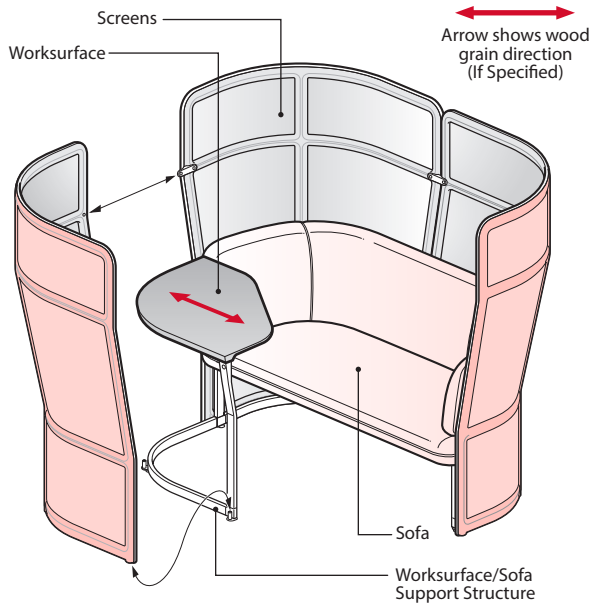

### Dimensions – Top View

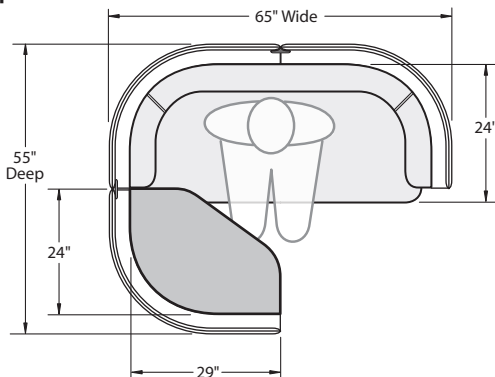

### Front View

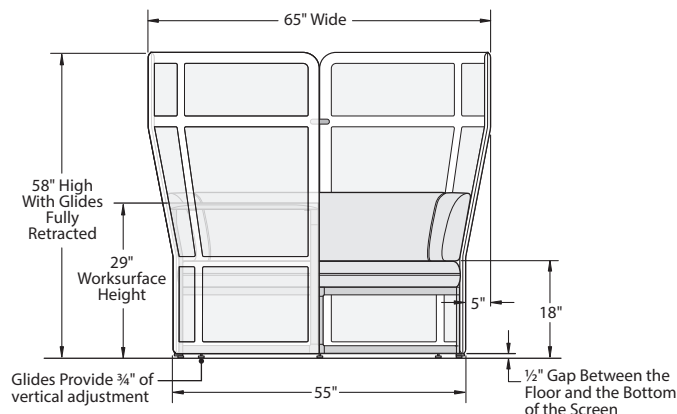

## Component Materials/Finishes

COMPONENT NAME	MATERIALS/ FINISHES	
Screens	<ul style="list-style-type: none"> <li>• Screen is constructed of fabric adhered to a polyester shell.</li> <li>• Available in King, Class and Maya fabrics only.</li> <li>• Different fabric may be specified for inner and outer screen.</li> </ul>	
Sofa	(1) Leather	<ul style="list-style-type: none"> <li>• Top-stitch thread Color is specifiable.</li> <li>• Sofa fabric applied railroaded.</li> <li>• Linear or patterned fabric not recommended due to the manner in which fabric is applied.</li> <li>• COM yardage/ sq. footage: 3.25 / 58.5</li> </ul>
	(2) Fabric	
	(3) Faux Leather	
Worksurface	(P) Painted MDF	Worksurface includes Knife Edge on user side. (See Worksurface Edge Detail Page)
	(L) Laminate	
	(W) Wood Veneer	
Sofa/Worksurface Support Structure	Painted Steel – Matches Trim Color	

## Power Options

- A separately specified Bezel Utility Module may be field installed on the worksurface.
- A separately specified Hideaway Power Module may be field installed under the sofa.

### One Power Outlet (NEMA 5-15P)

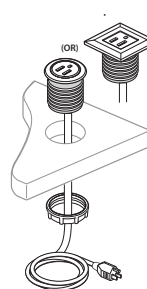

### Two Port USB Charger

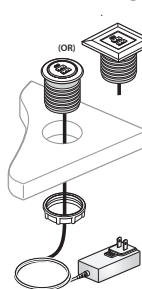

### Hideaway Power Module

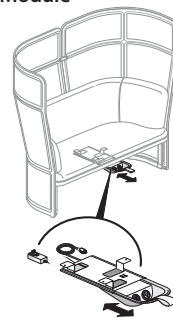

## Accessories

- Separately specified Pillows or Coat Hook can be used with this unit.

### Pillows

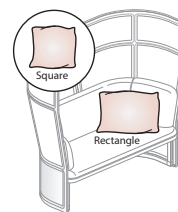

### Coat Hook

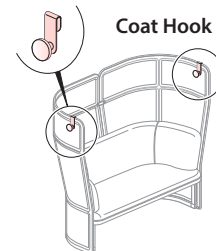

### Note

The separately specified Soft Storage cannot be used with the Corner Booth.

## Orientation Options

- Handedness is determined from a seated position.

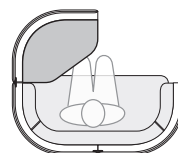

(L) Left Hand Option

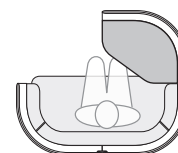

(R) Right Hand Option

# Product Details – Openest Collection

## Privacy Booth

- Corner Booth must be ordered as two individual items:
  - Item 1 includes: Five screens and one attached sofa
  - Item 2 includes: Worksurface
- Different fabric may be specified for inner and outer screen.
- Screens are not load bearing, tackable or reconfigurable.
- Not for use with monitor arms, adjustable keyboard pads, attached pedestals or suspended pedestals.

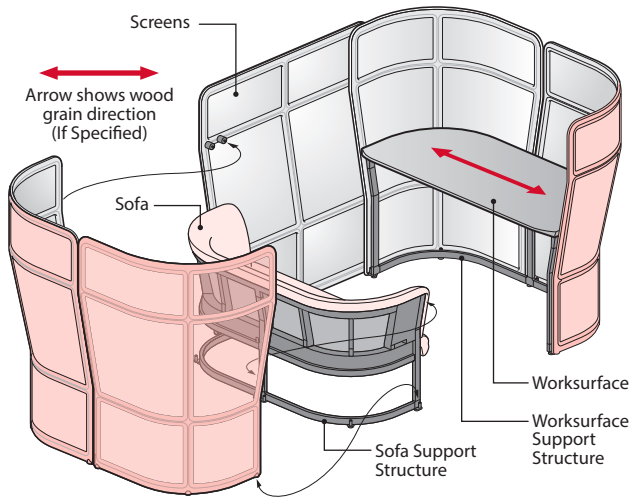

### Dimensions – Top View

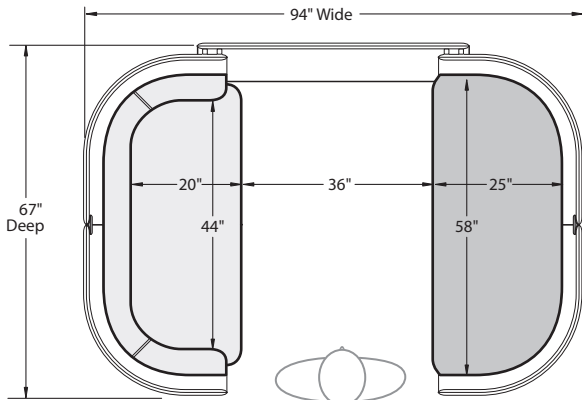

### Front View

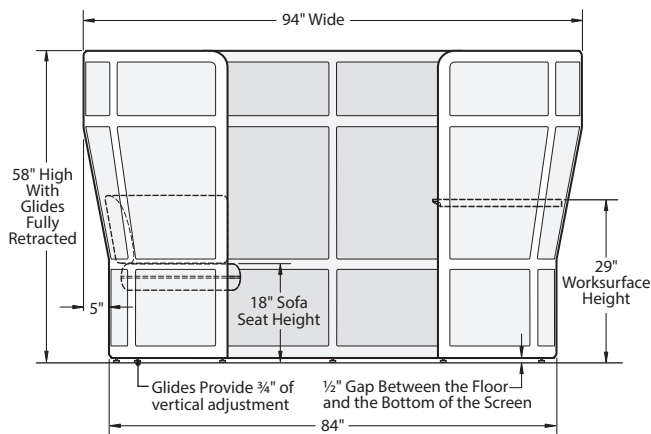

## Component Materials/Finishes

COMPONENT NAME	MATERIALS/ FINISHES	
Screens	<ul style="list-style-type: none"> <li>• Screen is constructed of fabric adhered to a polyester shell.</li> <li>• Available in King, Class and Maya fabrics only.</li> <li>• Different fabric may be specified for inner and outer screen.</li> </ul>	
Sofa	(1) Leather	<ul style="list-style-type: none"> <li>• Sofa top-stitch thread color is specifiable.</li> <li>• Sofa fabric applied railroad.</li> <li>• Linear or patterned fabric not recommended due to the manner in which fabric is applied.</li> <li>• COM yardage/ sq. footage: 3.25 / 58.5</li> </ul>
	(2) Fabric	
	(3) Faux Leather	
Worksurface	(P) Painted MDF	Worksurface includes Knife Edge on user side. (See Worksurface Edge Detail Page)
	(L) Laminate	
	(W) Wood Veneer	
Sofa/Worksurface Support Structures	Painted Steel – Matches Trim Color	

## Power Options

- A separately specified Bezel Utility Module may be field installed on the worksurface.
- A separately specified Hideaway Power Module may be field installed under the sofa.

### One Power Outlet (NEMA 5-15P)

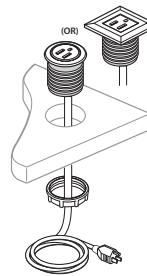

### Two Port USB Charger

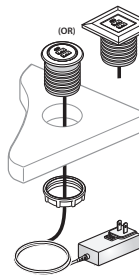

### Hideaway Power Module

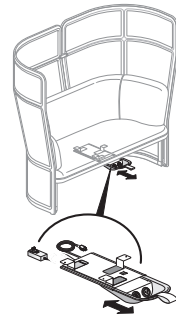

## Accessories

- Separately specified accessories like Pillows, Soft Storage or Coat Hook may be added.

### Pillows

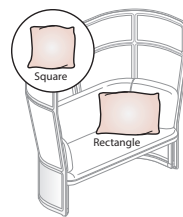

### Soft Storage

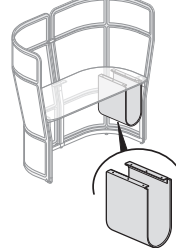

### Coat Hook

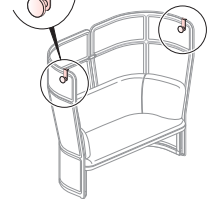

## Orientation Options

- Privacy Booth may be specified right or left handed.

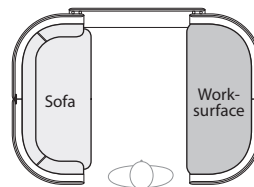

(L) Left Hand Option

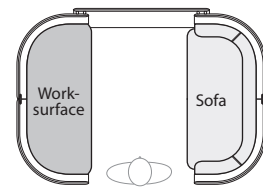

(R) Right Hand Option

# Product Details – Openest Collection

## Conference Booth

- Conference Booth is ordered as two individual items:
  - Item 1 includes: Five screens and two attached sofas
  - Item 2 includes: Worksurface and optional Monitor Mount.
- Different fabric may be specified for inner and outer screen.
- Screens are not load bearing, tackable or reconfigurable.

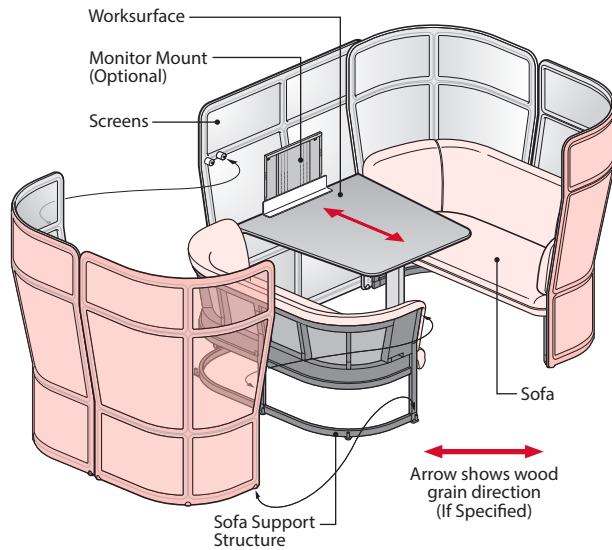

### Dimensions – Top View

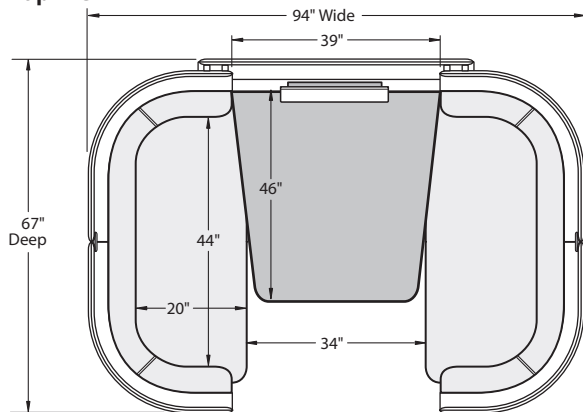

### Front View

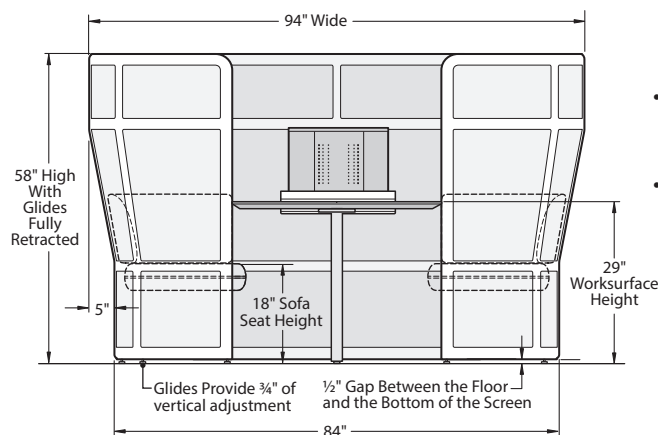

## Component Materials/Finishes

COMPONENT NAME	MATERIALS/ FINISHES	
Screens	<ul style="list-style-type: none"> <li>• Screen is constructed of fabric adhered to a polyester shell.</li> <li>• Available in King, Class and Maya fabrics only.</li> <li>• Different fabric may be specified for inner and outer screen.</li> </ul>	
Sofa	<ul style="list-style-type: none"> <li>(1) Leather</li> <li>(2) Fabric</li> <li>(3) Faux Leather</li> </ul>	<ul style="list-style-type: none"> <li>• Sofa top-stitch thread color is specifiable.</li> <li>• Sofa fabric applied railroad.</li> <li>• Linear or patterned fabric not recommended due to the manner in which fabric is applied.</li> <li>• Total COM yardage/ sq. footage: 6.5 / 117</li> </ul>
Worksurface	<ul style="list-style-type: none"> <li>(P) Painted MDF</li> <li>(L) Laminate</li> <li>(W) Wood Veneer</li> </ul>	
Sofa/Worksurface Support Structures	Painted Metal – Matches Item 1 Trim Color	
Monitor Mount (Optional)	Table Mounting Bracket	Painted Metal – Standard in Black
	Front and Rear Trim	Painted Metal – Matches Item 2 Trim Color

## Power Options

- A separately specified Bezel Utility Module may be field installed on the worksurface.
- A separately specified Hideaway Power Module may be field installed under the sofa.

### One Power Outlet (NEMA 5-15P)

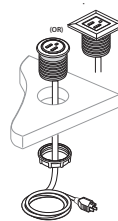

### Two Port USB Charger

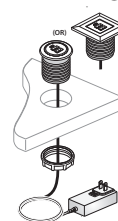

### Hideaway Power Module



## Accessories

- Separately specified accessories like the Pillows or the Coat Hook may be added.

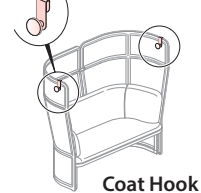
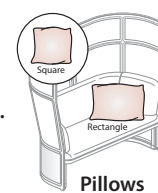

## Monitor Mount Option

- The optional Monitor Mount is designed to fit most brands of 32" monitors with centrally located VESA® mounting patterns with widths between 100mm-300mm and heights between 100mm-300mm.
- The monitor and any other mounted equipment such as video conferencing camera may not exceed the 70lbs. maximum load capacity.
- Monitor can be adjusted vertically in 1/2" increments.

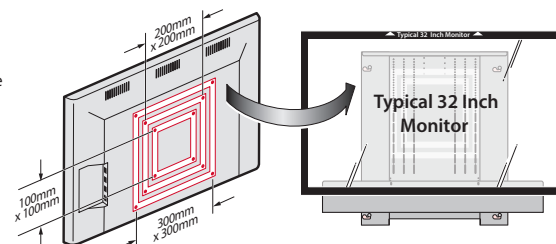

## Product Details – Openest Collection

### Double Booth

- Freestanding unit includes three screens and an attached Double Sofa with a painted steel support structure.
- Different fabric may be specified for inner and outer screen.
- Screens are not load bearing, tackable or reconfigurable.

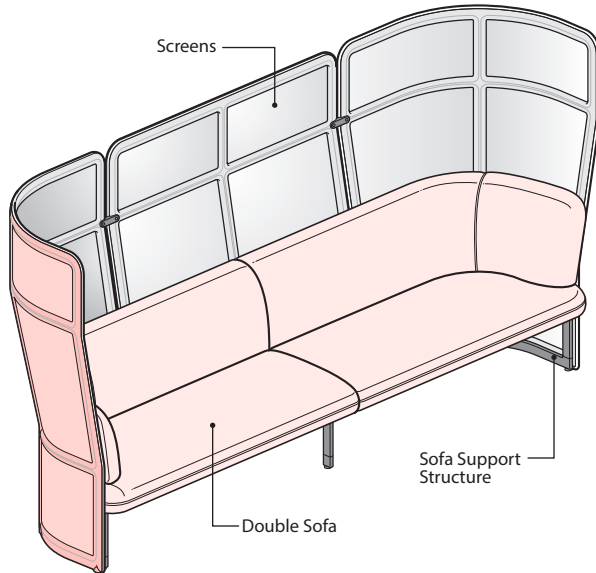

### Dimensions – Top View

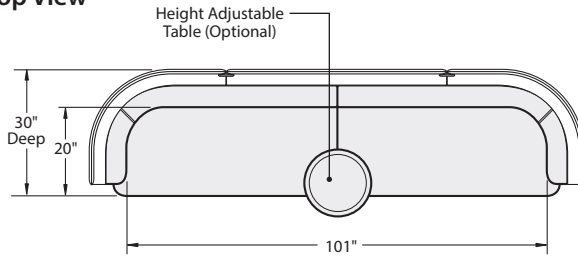

### Front View

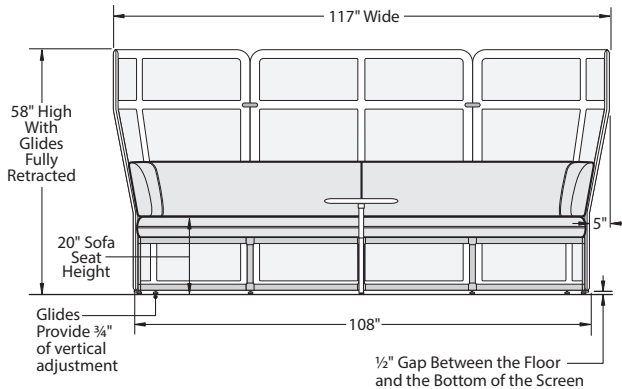

### Component Materials/Finishes

COMPONENT NAME	MATERIALS/ FINISHES				
Screens	<ul style="list-style-type: none"> <li>• Screen is constructed of fabric adhered to a polyester shell.</li> <li>• Available in King, Class and Maya fabrics only.</li> <li>• Different fabric may be specified for inner and outer screen.</li> </ul>				
Sofa	<table border="1"> <tr> <td>(1) Leather</td> <td rowspan="3"> <ul style="list-style-type: none"> <li>• Sofa top-stitch thread color is specifiable.</li> <li>• Sofa fabric applied railroaded.</li> <li>• Linear or patterned fabric not recommended due to the manner in which fabric is applied.</li> <li>• COM yardage/ sq. footage: 6 / 108</li> </ul> </td> </tr> <tr> <td>(2) Fabric</td> </tr> <tr> <td>(3) Faux Leather</td> </tr> </table>	(1) Leather	<ul style="list-style-type: none"> <li>• Sofa top-stitch thread color is specifiable.</li> <li>• Sofa fabric applied railroaded.</li> <li>• Linear or patterned fabric not recommended due to the manner in which fabric is applied.</li> <li>• COM yardage/ sq. footage: 6 / 108</li> </ul>	(2) Fabric	(3) Faux Leather
(1) Leather	<ul style="list-style-type: none"> <li>• Sofa top-stitch thread color is specifiable.</li> <li>• Sofa fabric applied railroaded.</li> <li>• Linear or patterned fabric not recommended due to the manner in which fabric is applied.</li> <li>• COM yardage/ sq. footage: 6 / 108</li> </ul>				
(2) Fabric					
(3) Faux Leather					
Sofa Support Structure	Painted Steel				
Height Adjustable Table (Optional)	Painted MDF	<ul style="list-style-type: none"> <li>• Available in Black, Polar, Stormy or Vapor</li> </ul>			
	Plank White Oak	<ul style="list-style-type: none"> <li>• Wood tops are designed to be unique, using solid wood planks with a clear, low-gloss finish showing natural variation.</li> </ul>			
	Plank Walnut				

### Height Adjustable Table Option

- The Booth may be specified with a Height Adjustable Table which replaces the center leg under the sofa.
- The table is installed at the center of the sofa to function as a support leg and may not be repositioned.

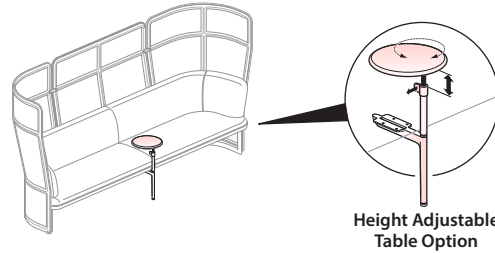

### Power Components

- A separately specified Hideaway Power Module may be field installed under the sofa.

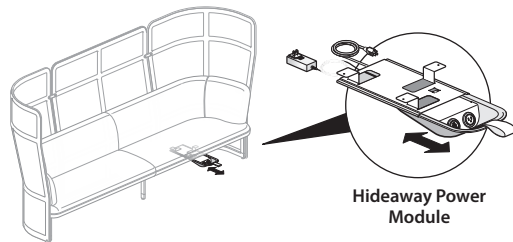

### Accessories

- Separately specified accessories such as Pillows or a Coat Hook may be added.

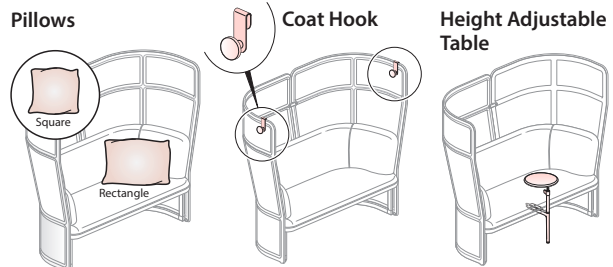

# Product Details – Openest Collection

## Height Adjustable Table

- Includes table top with height adjustable leg.
- Top Rotates 360° with a 4" height adjustment range.
- May be attached below all Openest sofas.

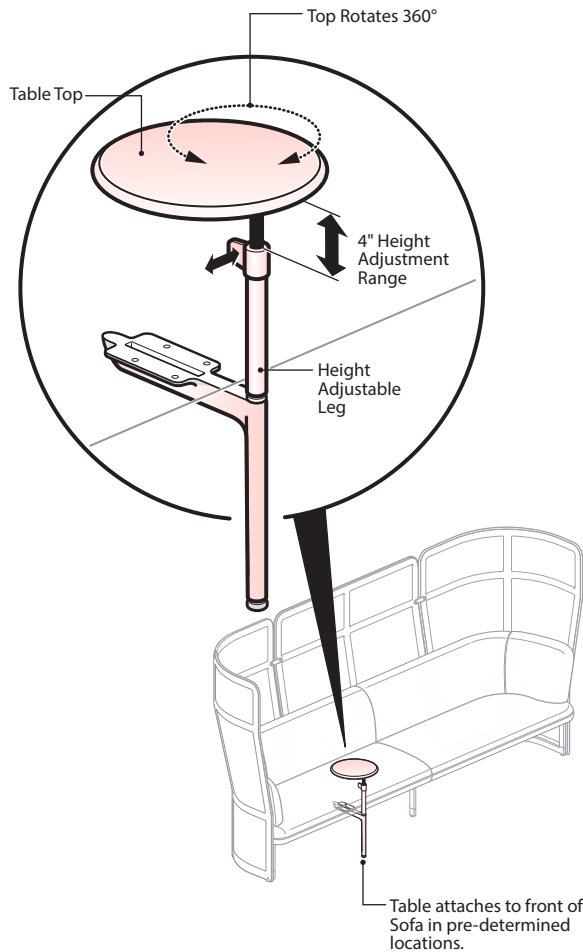

### Dimensions

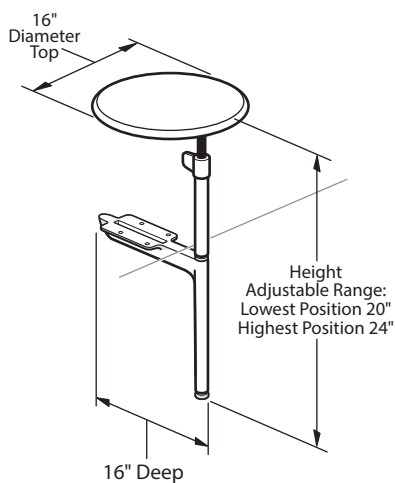

### Component Materials/Finishes

COMPONENT NAME	MATERIALS/ FINISHES	
Height Adjustable Leg	Painted Cast Aluminum – Specified Trim Color	
Table Top	Painted MDF	• Available in Black, Polar, Stormy or Vapor
	Plank White Oak	• Wood tops are designed to be unique, using solid wood planks with a clear, low-gloss finish showing natural variation.
	Plank Walnut	

### Sofa Type Options

#### (F) Feather Sofa Option:

- The Height Adjustable Table with option (F) for Feather Sofas, is a field installed retrofit kit that can be used to replace one of the legs on the front of the Feather Sofa.

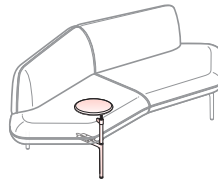

Feather Sofa – Symmetrical  
(Shown with left hand Leg replaced with the Height Adjustable Table retrofit kit)

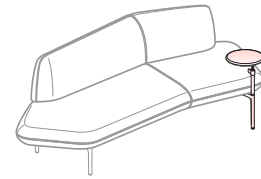

Feather Sofa – Asymmetrical  
(Shown with right hand Leg replaced with the Height Adjustable Table retrofit kit)

#### (B) Booth Sofa Option:

- The Height Adjustable Table with option (B) for Booth Sofas, is a field installed Table that attaches to the front of a sofa on a Single Booth or Double Booth.
- The table may only be installed on the sofa in the pre-drilled locations shown below.

#### Single Booth – Table Locations (Top View)

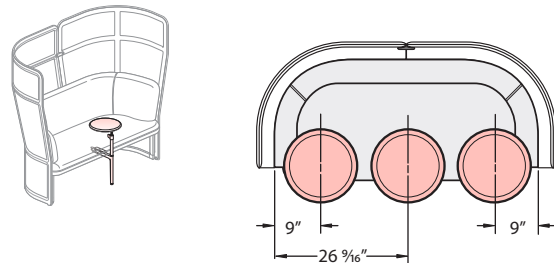

#### Double Booth – Table Locations (Top View)

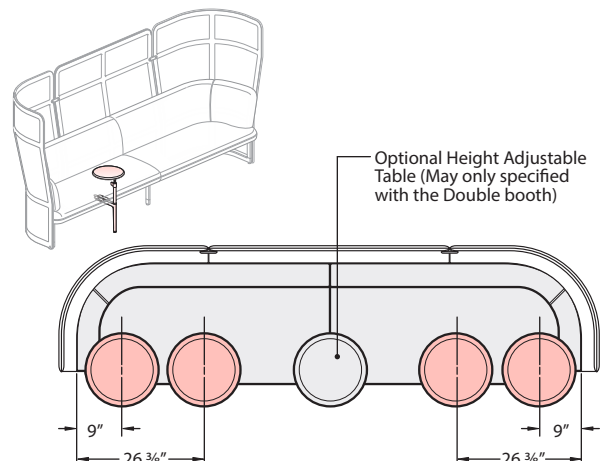

## Product Details – Openest Collection

### Accessories

#### Coat Hook

- Includes one coat hook with painted metal bracket and white oak wood surface.
- Maximum weight load is 10 lbs.
- Can be used on screens.

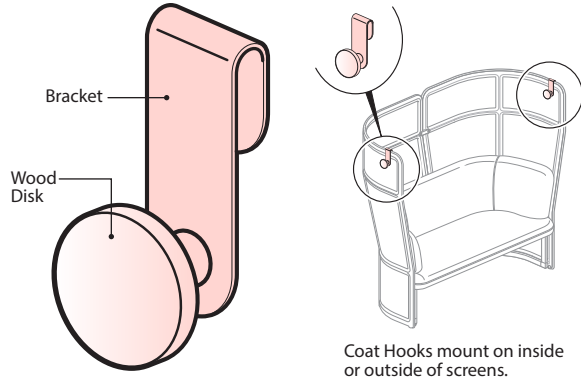

#### Soft Storage

- Includes soft storage unit with attachment hardware.
- Maximum weight capacity is 30 lbs.
- Available in Big Arrow fabric only. COM not available.
- Can be used on worksurfaces 16" deeper.

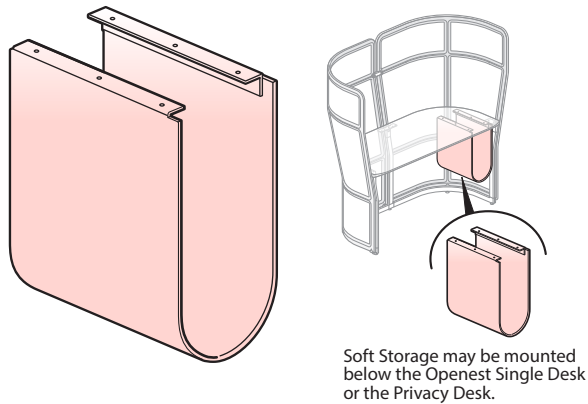

#### Pillows

- Includes one pillow with 100% polyester fill.
- Available in square or rectangle shapes.

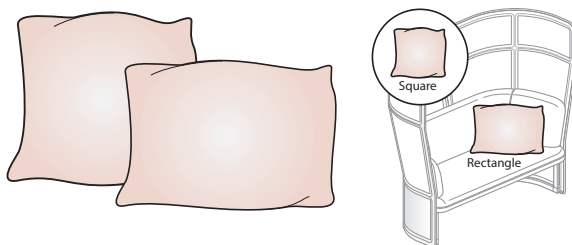

### Component Materials/Finishes

COMPONENT NAME	MATERIALS/ FINISHES
Coat Hook Bracket	Painted Metal – matches Trim Color
Wood Disk	White Oak

- Note** • The separately specified Coat Hook should not be used with the Double Desk if it is specified with the optional Monitor Mount.

### Dimensions

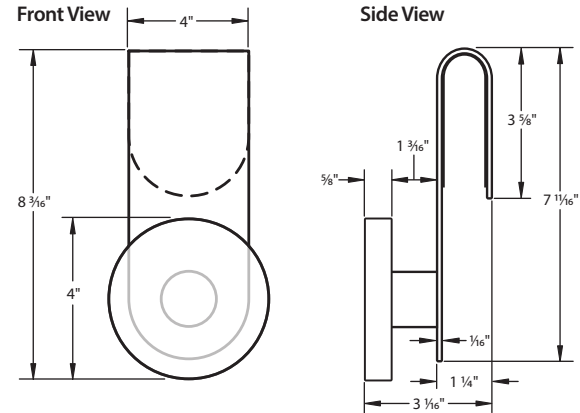

### Component Materials/Finishes

COMPONENT NAME	MATERIALS/ FINISHES
Soft Storage Unit	<ul style="list-style-type: none"> <li>• Available with Big Arrow fabric only.</li> <li>• COM not available.</li> </ul>
Attachment Bracket	White Plastic

- Note** • Not for use on with Openest sofas.  
• Not for use on Openest Double Desk or Corner Booth.

### Dimensions

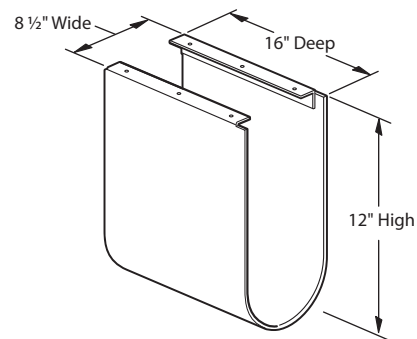

### Component Materials/Finishes

COMPONENT NAME	MATERIALS/ FINISHES
Pillow	<ul style="list-style-type: none"> <li>• Specify fabric and color</li> <li>• 100% Polyester Fill</li> <li>• COM Yardage: 0.75</li> </ul>

### Dimensions

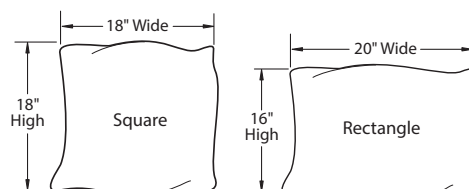

# Product Details – Openest Collection

## Power Components

### Hideaway Power Module

- Includes power drawer, soft drawer pull, one power outlet, one two port USB outlet, cord with plug, cord with transformer and plug, and mounting hardware.
- UL listed power outlet provides one NEMA 5-15R outlet.
- USB outlet consists of two USB outlets with 1000mA of charging per USB outlet powered from UL listed transformer.
- Can be used on Openest booth sofa or Feather sofa.
- Mounts to under structure of sofa.
- For use with 120 volt 60 hertz power source only.
- Requires field installation.
- Application may require approval of local authority having jurisdiction (AHJ); ensure compliance before placing orders and installing.

### Sofa Type Option

- Booth Sofas and Feather Sofas require different mounting brackets for installation, specify Sofa Type to ensure module is equipped with the correct mounting bracket for installation.
- Specify (B) Booth - for installation on all Booth Sofas, or specify (F) Feather - for installation on all Feather Sofas.

### Component Materials/Finishes

COMPONENT NAME	MATERIALS/ FINISHES
Power Drawer	• Standard with supplier white only.
Soft Drawer Pull	• Polypropylene Strap • Standard with orange color only.
USB Outlet	• White Bezel • UL Listed provides one NEMA 5-15R Outlet.
Power Outlet	• White Bezel • USB outlet consists of two USB outlets with 1000mA of charging per USB outlet powered from UL listed transformer.
Mounting Bracket	• Painted Metal – Standard in Black
Cord with Transformer and Plug	• Black cord, transformer/plug
Cord with Plug	• White cord/plug

### Hideaway Power Module for Booth Applications

Option (B) Booth  
HOPD-0006-B

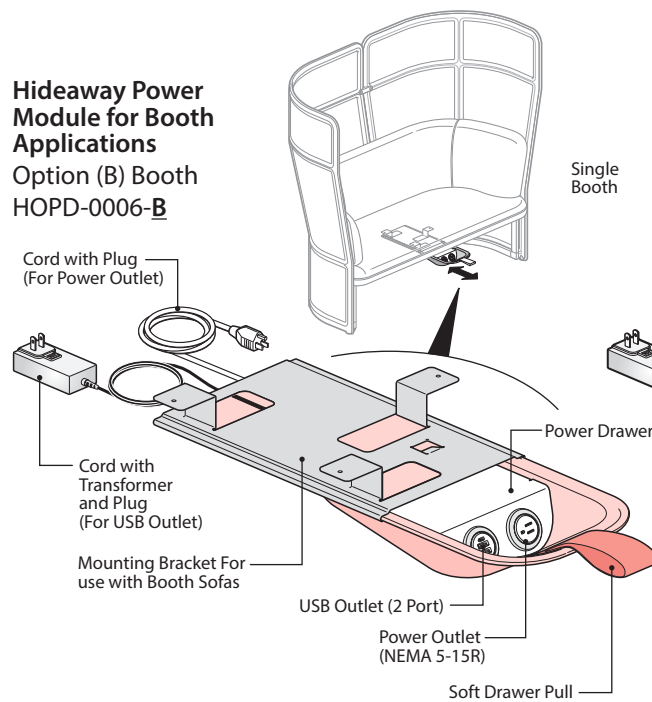

### Hideaway Power Module for Feather Sofa Applications

Option (F) Feather  
HOPD-0006-F

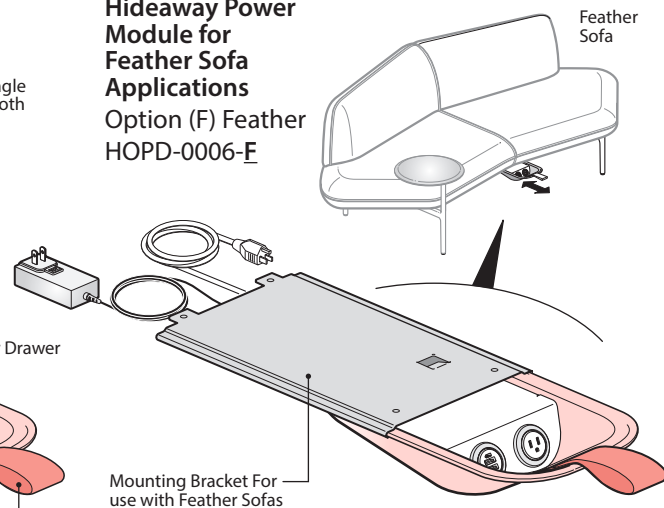

Side View

### Dimensions

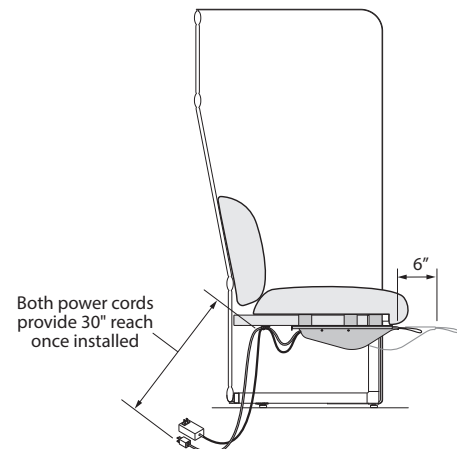
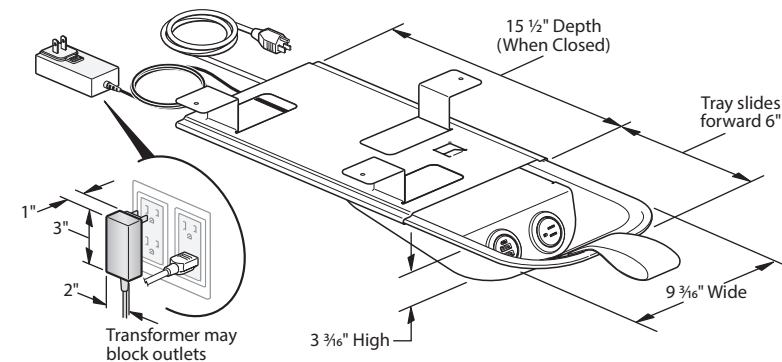

# Product Details – Openest Collection

## Power Components

### Bezel Utility Module

- Includes: Either a round or square faced Power Module and mounting hardware.
- Power configuration includes one cord with plug (NEMA 5-15P) round or square faced Power Module and mounting hardware.
- USB configuration includes one cord with voltage transformer plug round or square faced Power Module with two USB ports providing 1000mA of charging power (5 volts) per USB outlet and mounting hardware.
- For use on surfaces 0.75"-2.0" thick.
- Available in black or supplier white only.
- For use with 120 volt 60 hertz power source only.
- Requires field cut 1.75" (44mm) hole and field installation.
- Application may require approval of local authority having jurisdiction (AHJ); ensure compliance before placing orders and installing.

### Component Materials/Finishes

COMPONENT NAME	MATERIALS/ FINISHES
USB Outlet	<ul style="list-style-type: none"> <li>• Available with a (B) Black or (W) White Bezel.</li> <li>• UL Listed provides one NEMA 5-15R Outlet.</li> </ul>
Power Outlet	<ul style="list-style-type: none"> <li>• Available with a (B) Black or (W) White Bezel.</li> <li>• USB outlet consists of two USB outlets with 1000mA of charging per USB outlet powered from UL listed transformer.</li> </ul>
Cord with Transformer and Plug	<ul style="list-style-type: none"> <li>• Black cord, transformer/plug</li> </ul>
Cord with Plug	<ul style="list-style-type: none"> <li>• White cord/plug</li> </ul>

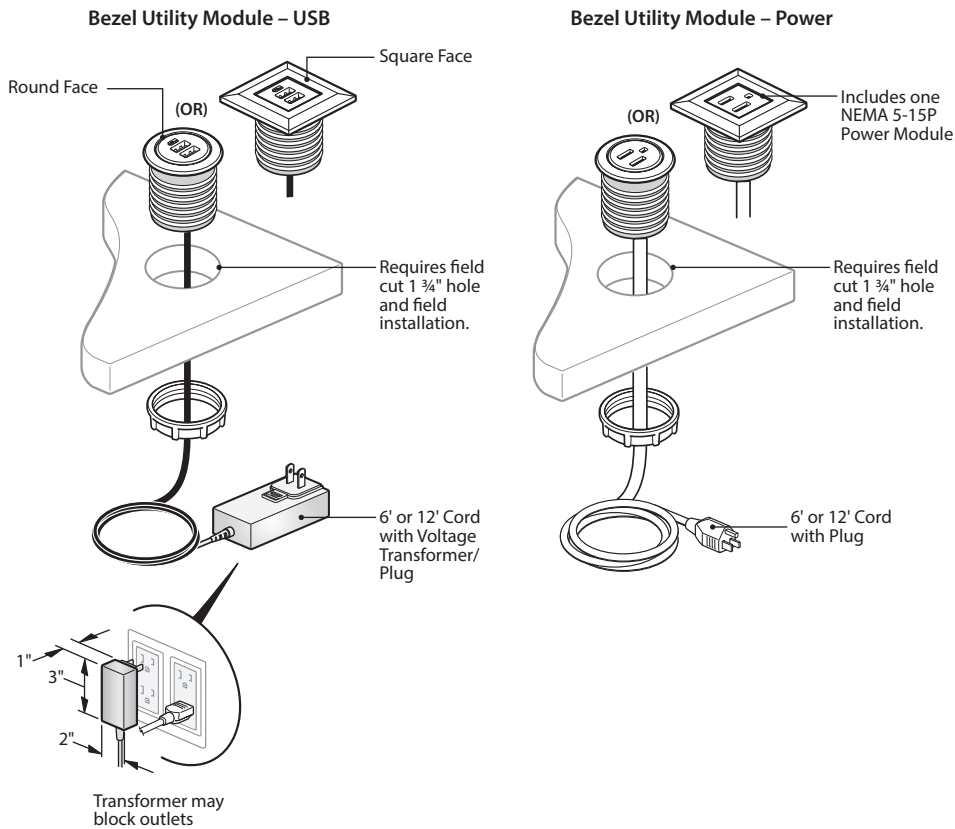



# Product Details – Openest Collection

## Worksurface Edge Details

- Openest worksurfaces may be specified as Painted MDF, Laminate or Wood Veneer.
- The User Edge is the edge facing the user (always knife edge).
- The Screen Edge is the edge facing the screen (edge shape varies by finish).

### Painted MDF

- Worksurface is one piece with no Edgebanding.
- User edge is Knife Edge and the Screen Edges are angled.

#### User Edge

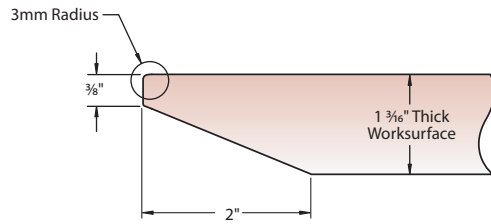

#### Screen Edges

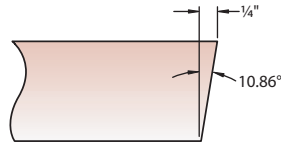

### Laminate

- User edge is Knife Edge with 3mm laminate edgeband.
- Screen edges are straight with 1mm laminate edgebanding.

#### User Edge

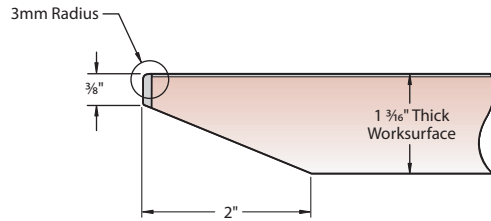

#### Screen Edges



### Wood

- User edge is Knife Edge with 3mm wood edgeband.
- Screen edges are angled with wood edgebanding.

#### User Edge

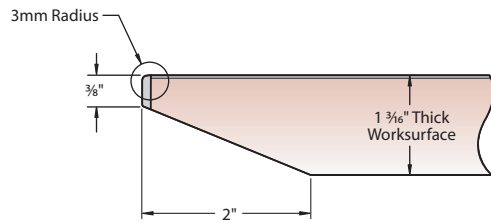

#### Screen Edges

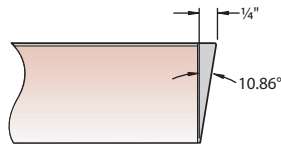

## User Edge/Screen Edge Locations By Product

### Single/Double Desk

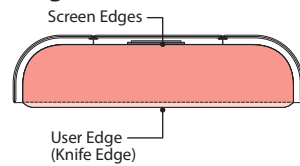

### Corner Booth

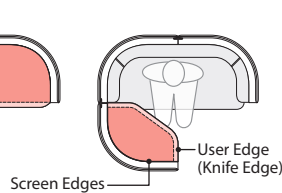

### Privacy Desk

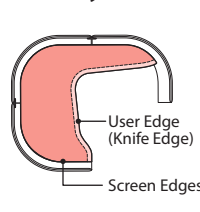

### Privacy Booth

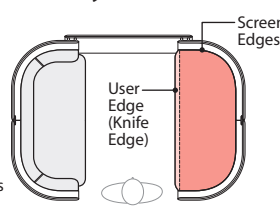

### Conference Booth

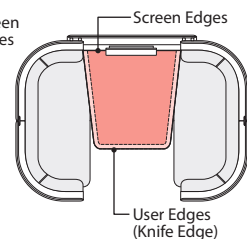

**This page intentionally left blank.**

## Product Application – Openest Collection

## Product Application – Openest Collection

### Tips and Tricks - Collaborative Spaces

Where people come together for group conversations, formal meetings, breakout sessions, and casual chats

- Be mindful of whether individual spaces face toward or away from each other and adjacent benching areas.
- Consider multiple sets of Plume 3 screens for flexibility and configurability.
- Use Plume screens to break up open spaces into smaller group work areas.
- Be mindful of activities in spaces next to screens to help people on both sides maintain focus.
- Offer choices to workers with a mix of individual nooks, casual spaces, and assigned benching areas.
- Repeat a row of booths or desks to enclose the front and back of spaces.

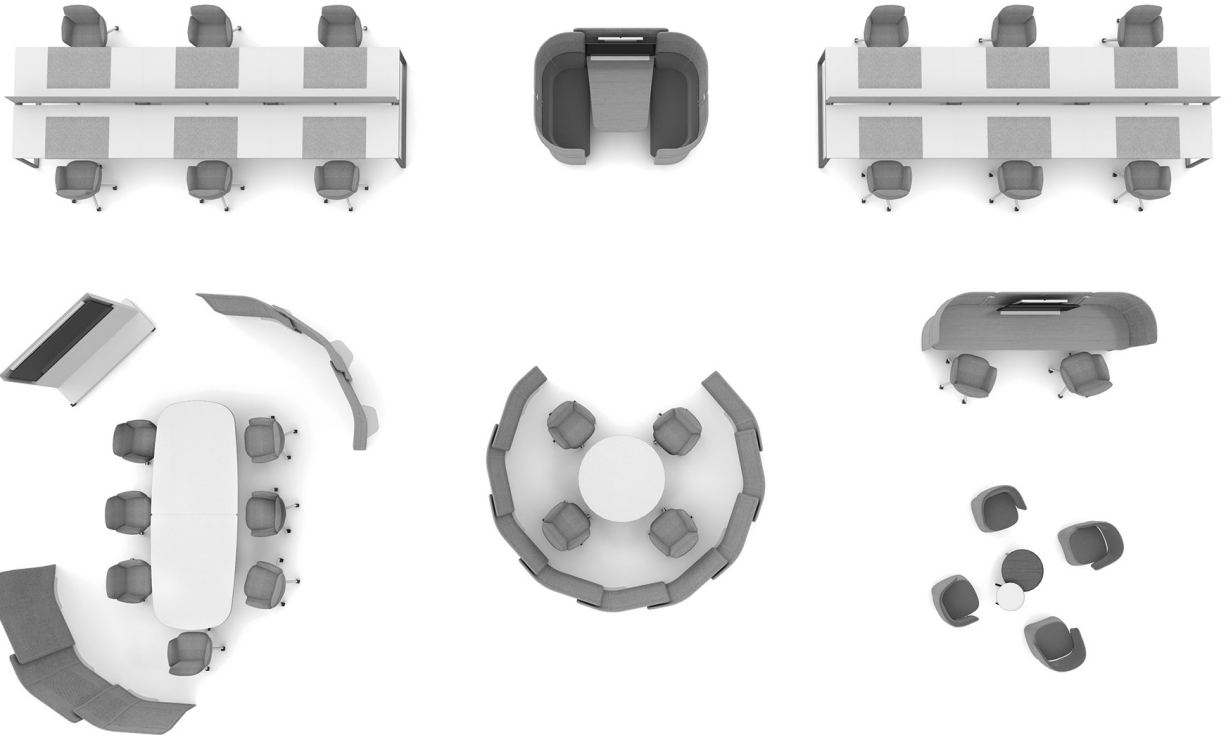

#### Additional items to consider:

- Openest is not recommended for frequent relocation. Plan to install at final location.
- Openest is not meant to be user relocated. Assembled product must be moved by professionally trained installers.
- Verify power and data locations. Access Flooring allows power and data to be easily located at installation site.
- Workware Wireless is the recommended technology solution, requires building power and data at the installation location.
- When designing a floorplate; plan for various privacy needs.
- Finish spaces with appropriate accessories. Please refer to the Product Details section or Price Book pages by component for accessory options.

## Product Application – Openest Collection

### Tips and Tricks - Thinking Spaces

**Private spaces that provide a retreat for thinking, research, focus, and strategic conversations.**

- Use Openest components to add interest with functional and inviting spaces.
- Combine lounge pieces with workware™ technology solutions to lend a casual feeling to group workspaces.
- Use Chick Poufs to create inviting spaces where people can work in various postures.
- Take advantage of the integrated hideaway power to support mobile technology.
- Consider 5' of space between each booth or desk to maintain visual geometry and allow easy circulation.
- Leave breathing room between Plume screen sets to enhance the landscape.

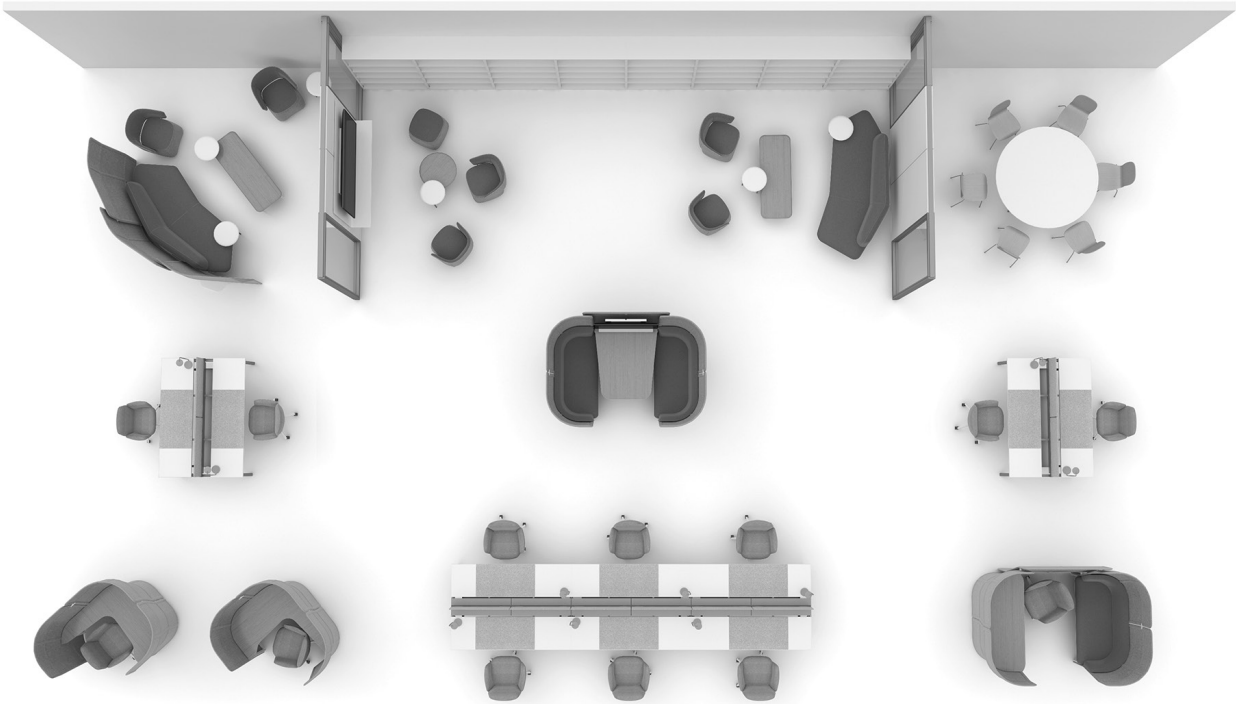

## Product Application – Openest Collection

### Tips and Tricks - Touchdown Spaces

#### Unassigned spaces for mobile workers, visitors and quick or casual collaborations.

- Plan screen placement strategically, leveraging existing walls to help enclose spaces or create sitting areas on both sides of a single screen.
- When placing screens, consider whether you want to allow or block sunlight.
- Use a set of Plume 9 Screens with a table to enclose a small group area.
- Keep acoustics in mind when incorporating screens as they can provide some acoustical privacy.
- Add a Conference Booth with workware™ technology to support impromptu meetings and collaboration.
- Plan 5' of space between booths and desks to maintain visual geometry and allow easy circulation.

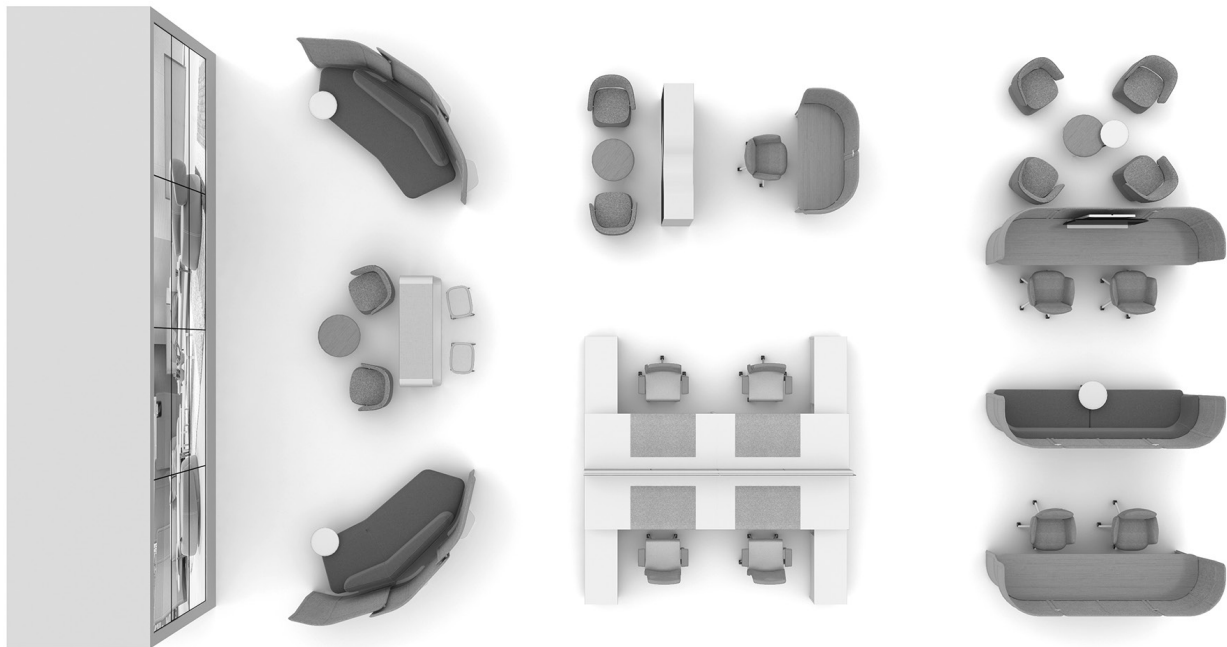

#### Additional items to consider:

- Openest is not recommended for frequent relocation. Plan to install at final location.
- Openest is not meant to be user relocated. Assembled product must be moved by professionally trained installers.
- Verify power and data locations. Access Flooring allows power and data to be easily located at installation site.
- Workware Wireless is the recommended technology solution, requires building power and data at the installation location.
- When designing a floorplate; plan for various privacy needs.
- Finish spaces with appropriate accessories. Please refer to the Product Details section or Price Book pages by component for accessory options.

## Product Application – Openest Collection

### Tips and Tricks - Social Spaces

**Casual areas where people come together for social conversations and refreshments.**

- Use screens or booths to form cozy settings for casual collaboration.
- Combine two Double Booths with two round tables to create a restaurant-style environment.
- Mix Openest lounge pieces with existing architecture elements to divide areas.
- Use a set of Plume 3 Screens to shield a group area from activities in the room.
- Blend Chick Poufs with sofas and screens to create relaxed settings for conversations.
- Place two or three Chick Poufs around a table for quick drop-in meetings.

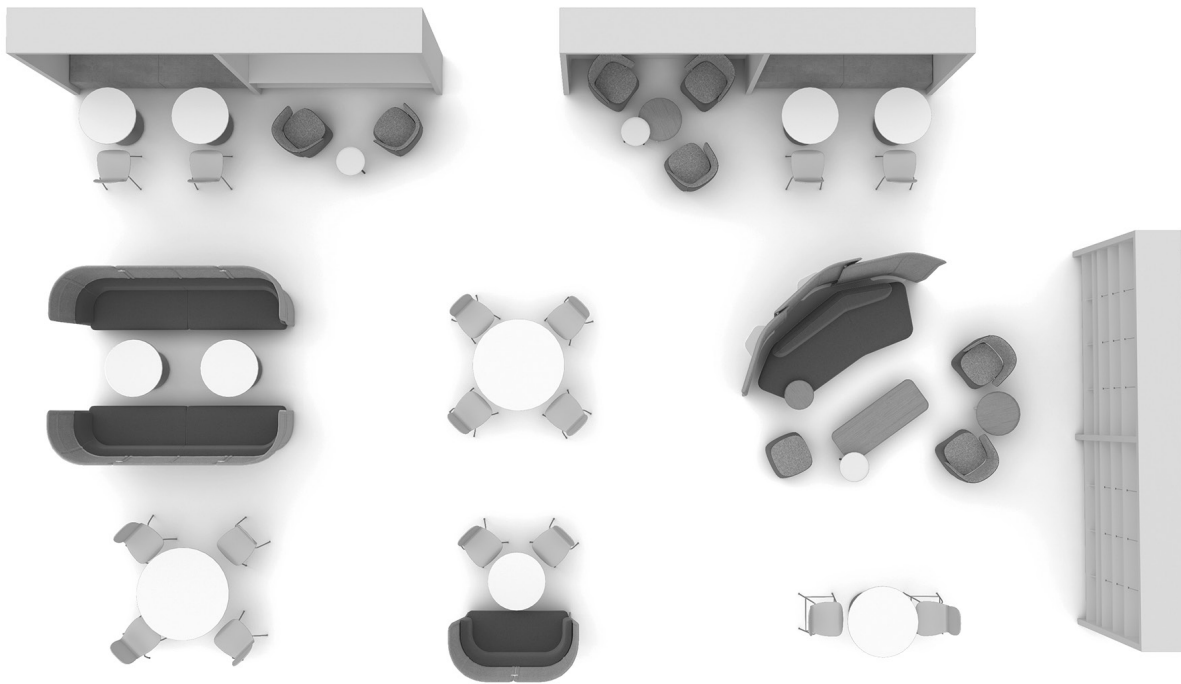

**This page intentionally left blank.**



# Technical Specifications – Openest Collection

## Technical Specifications – Openest Collection

### Wood Composite Materials

Wood composite materials in Openest products are engineered composite panels with a minimum 90% wood fiber content with at least 10% post-consumer and 80% pre-consumer wood fiber bonded with resin. All parts with a wood composite core are 3rd party certified compliant with GREENGUARD® and ANSI/BIFMA Standards for low emitting products. The composite core is 3rd party certified compliant with California Air Resource Board requirements for Phase 2 formaldehyde emission levels.

### Steel

#### Steel Gauge Overview

ACCESSORY	MATERIAL
Plume Screen	Base: 0.250" CRS & 0.56" dia. steel rod
Feather Sofa	N/A
Chick Pouf with Back	Base pivot: 0.250" CRS Pivot back: 0.312" dia. steel rod
Sprig Table	N/A
Desk	Mount: 11 ga CRS Frame: 16 ga steel tubing
Booths	Mount: 11 ga CRS Frame: 16 ga steel tubing
Height Adjustable Table	Mount: 7 ga CRS Adjustment mech: 1.0" steel tubing, 304 SS shaft
Coat Hook	16 ga CRS
Soft Storage	N/A
Pillows	N/A
Hideaway Power Module	16 & 18 ga CRS
Monitor Mount	16 & 20 ga CRS

### Plume Screens

Screens are made of compression formed, non-woven polyester fiber, with polyester fabric laminated to the front and back. Bases are powder coated 0.250" thick CRS plates with 0.56" diameter pins that when fully assembled, protrude into the bottom of the screen. Connectors are a combination of; powder coated aluminum, powder coated steel, zinc plated steel, and synthetic rubber O-rings.

### Feather Sofa

Upholstered seats and backs have plywood frame construction. Multi-density molded foam and Sytex webbing is used to achieve seating comfort. Varying types of polyester blended fabrics are used in combination with lofted polyester fiber conjugate for final covering. Vertical sofa support is established through use of powder coated die cast aluminum legs, containing 95% recycled material and black ABS glides.

The Feather Sofa can be ordered with an optional table composed of; 100% recycled wood content CARB compliant MDF, clear low gloss finished white oak, or clear low gloss finished walnut. Vertical table support is established through use of a powder coated die cast aluminum leg, containing 95% recycled material and a black ABS glide.

## Technical Specifications – Openest Collection

### Chick Pouf

#### Chick Pouf – Base (Included with Chick Pouf with Back and without Back)

The Chick Pouf Base (with or without Back) features an upholstered seat which is made of plywood frame construction. Multi-density molded foam and Sytex webbing is used to achieve seating comfort. Varying types of polyester blended fabric are used in combination with lofted polyester fiber conjugate for final covering. The base pivot mount is made of 0.250" thick CRS with 0.628" diameter CRS pivot pins and bolts directly to the base frame. The pivot spacer between the back and base is powder coated die cast aluminum containing 95% recycled material. Bottom closeout cover is 0.060" thick black ABS. Glides are black nylon and thread into to the base.

#### Chick Pouf – Back (Included with Chick Pouf with Back)

The Chick Pouf flip down back is composed of a high-density polyethylene inner shell with a 0.312" diameter CRS welded wire inner frame. This shell is over-molded with polyurethane foam. Varying types of polyester blended fabrics are used in combination with lofted polyester fiber conjugate for final covering. A two-inch polypropylene strap is sewn in location to assist with positioning the back.

#### Chick Pouf – Large Square – No Back

Features an upholstered seat which is made of plywood frame construction. Multi-density molded foam and Sytex webbing is used to achieve seating comfort. Varying types of polyester blended fabric are used in combination with lofted polyester fiber conjugate for final covering. Bottom closeout cover is a black fabric. Optional Glides are black nylon and attached with a fastener into to the base. Felt pads can be selected. Optional caster are also available in hard or soft versions.

#### Chick Pouf – Rectangle – No Back

Features an upholstered seat which is made of plywood frame construction. Multi-density molded foam and Sytex webbing is used to achieve seating comfort. Varying types of polyester blended fabric are used in combination with lofted polyester fiber conjugate for final covering. Bottom closeout cover is a black fabric. Optional Glides are black nylon and attached with a fastener into to the base. Felt pads can be selected. Optional caster are also available in hard or soft versions.

#### Chick Pouf – Round – No Back

Features an upholstered seat which is made of plywood frame construction. Multi-density molded foam and The webbing is plastic over fiberglass used to achieve seating comfort. Varying types of polyester blended fabric are used in combination with lofted polyester fiber conjugate for final covering. Bottom closeout cover is a black fabric. Optional Glides are black nylon and attached with a fastener into to the base. Felt pads can be selected. Optional casters are also available in a soft breaking versions.

### Sprig Table

Sprig Tables are available in three different types of wood; 100% recycled wood content CARB compliant MDF, clear low gloss finished white oak, and clear low gloss finished walnut. Vertical table support is established through use of powder coated die cast aluminum legs, containing 95% recycled material and black ABS glides.

### Desks

Desk screens are made of compression formed, non-woven polyester fiber, with polyester fabric laminated to the front and back. Connectors are a combination of; powder coated aluminum, powder coated steel, zinc plated steel, synthetic rubber o-ring, and ABS. Framing consist of 16 ga. CRS powder coated tubing and die cast aluminum. Adjustments are made using steel cored polypropylene levelers. Work surface top construction: Standard core consists of 1.125" thick particleboard. Laminate top face is 0.028" thick high-pressure laminate and underside is 0.028" thick backer for balanced construction. Veneer top face is 0.020" thick natural or recon veneer and 0.020" thick backer for balanced construction.

Edges for laminate tops: Edge options include 0.118" thick edge band made of Acrylonitrile Butadiene Styrene (ABS); knife edge (on Green core only), constructed with 0.0118" thick edge band that runs 0.375" down the perimeter of the edge before transitioning to a taper; 0.118" thick T-mold and 0.625" thick contoured (Cascade) plastic t-mold. Edges for wood tops: Edge options include 0.100" thick wood edge band; knife edge (on Green core only), constructed with 0.100" edge band that runs 0.375" down the perimeter of the edge before transitioning to a taper; and 0.625" thick stick stock with cascade profile.

## Technical Specifications – Openest Collection

### Accessories

#### Height Adjustable Table

Height Adjustable Tables are available in three different types of wood; 100% recycled wood content CARB compliant MDF, clear low gloss finished white oak, and clear low gloss finished walnut. Vertical table support is established through use of die cast aluminum leg, containing 95% recycled material with a powder-coat finish applied over rust inhibiting phosphate pre-treatment, and an adjustable black ABS glide.

#### Coat Hook

The Coat Hook is formed 16 gauge steel and aluminum with a powder coat finish. The round end stop is clear low gloss finished white oak

#### Soft Storage

Soft storage options are made of two polyethylene extrusions sewn to a polyester blend fabric.

#### Pillows

Openest Pillows feature an outer shell of blended polyester fabric and a cotton-polyester micro-fiber filler.

#### Monitor Mount

Monitor Mounts are fabricated and formed 16 gauge steel, 20 gauge steel, and 0.190" aluminum. Finish is a powder-coat finish applied over rust inhibiting phosphate pre-treatment.

#### Hideaway Power Module

Hideaway Power Modules include two USB-B charging ports and one NEMA 5-15P outlet. Each USB port is capable of 1,000 mA 5V charging power. Power modules are available with either a 6 foot or 12 foot (3.6m) cord, having NEMA 5-15 two prong polarized plug or built in transformer. The slide system is made of 16 gauge formed steel and bottom cover is high impact polystyrene with a 2" wide polypropylene access strap.

#### Bezel Utility Module (Power Module)

Power module available with two USB-B charging ports or one NEMA 5-15P outlet. Each USB port is capable of 1,000 mA 5V charging power. Power modules are available with either a 6 foot or 12 foot (3.6m) cord, having a NEMA 5-15 two prong polarized plug.

### Booths

Booth screens are made of compression formed, non-woven polyester fiber, with polyester fabric laminated to the front and back. Connectors are a combination of; powder coated aluminum, powder coated steel, zinc plated steel, synthetic rubber O-ring, and ABS. Framing consist of 16 ga. CRS powder coated tubing and die cast aluminum. Adjustments are made using steel cored polypropylene levelers.

Work surface top construction: Core options include Standard and Green core. Standard core consists of 1.125" thick particleboard. Green core is constructed of 1.125" thick medium density fiberboard (mdf). Laminate top face is 0.028" thick high-pressure laminate and underside is 0.028" thick backer for balanced construction. Veneer top face is 0.020" thick natural or recon veneer and 0.020" thick backer for balanced construction.

Edges for laminate tops: Edge options include 0.118" thick edge band made of Acrylonitrile Butadiene Styrene (ABS); knife edge, constructed with 0.0118" thick edge band that runs 0.375" down the perimeter of the edge before transitioning to a taper. Edges for wood tops: Edge options include 0.100" thick wood edge band; knife edge, constructed with 0.100" edge band that runs 0.375" down the perimeter of the edge before transitioning to a taper.

Booth seating is made of plywood frame construction. Multi-density molded foam is used to achieve seating comfort. Varying types of polyester blended fabrics are used in combination with lofted polyester fiber conjugate for final covering.

This page intentionally blank

# Finish/Color Legend

## Wood Finishes

**Grade A**  
Double Cut

2P-RL	Applegate
WL-RL	Beachwood
2R-RL	Butternut
WE-RD	Dune
WJ-RE	Ebony
2N-RL	Echo
W3-HR	Harbor
LQ-RH	Hazel Walnut
WE-RT	Melba
W4-PB	Pebble
WC-RW	Wenge

**Grade B**  
Anegre Quarter Cut

NP-W15	Espresso
NP-W08	Golden
NP-W07	Light

Cherry

VC-CA1	Amber
VC-W23	American
VC-W33	Caramel
VC-W30	Heritage
VC-W32	Pacific

Cherry Quarter Cut

NX-U	Medium
------	--------

Maple

VP-LM	Light
VP-N	Natural
VP-AD	Sand

Maple Quarter Cut

NM-N	Natural
------	---------

Oak

VJ-W42	Brindle
VJ-W05	Natural

Rift Cut White Oak

NR-W15	Espresso
NR-W37	Fawn
NR-W40	Mocha
NR-W38	Tuxedo

Walnut

VR-W15	Espresso
VR-W21	Mahogany Satin on Walnut
VR-W31	Retro

Walnut Quarter Cut

NW-W35	Clear
NW-W15	Espresso
NW-W31	Retro
NW-W41	Verdant

Planked Wood

VB-W35	Plank Oak
VH-W35	Plank Walnut

## Laminate

**Grade A**  
Solid Color

H-34	Beige
H-AK	Chalk
H-8J	Charcoal
H-3J	Graphite
H-62	Gray Tone
H-WL	Linen
H-3P	Platinum
H-AA	Putty
H-3E	Smoke

Patterned

H-P1	Linen Casual
H-P2	Linen Classic
H-P3	Linen Crisp
H-P4	Linen Flax

Wood Grain

H-AM	Amber Cherry
H-AE	Maple
H-AD	Medium Cherry

**Grade B**  
Premium Wood Grain

H-KA	Brazilwood
H-KG	Columbian Walnut
H-KP	Field Elm
H-KN	Grey Elm
H-KM	Landmark Wood
H-KL	Neo Walnut
H-KC	New Age Oak
H-KR	Phantom Ecru
H-KS	Phantom Pearl
H-KD	River Cherry
H-KE	Sanara
H-KF	Williamsburg Cherry

## Edgeband

Solid Color

HP-34	Beige
HP-AK	Chalk
HP-8J	Charcoal
HP-3J	Graphite
HP-62	Gray Tone
HP-WL	Linen
HP-3P	Platinum
HP-AA	Putty
HP-3E	Smoke

Patterned Edgeband

HP-P1	Linen Casual
HP-P2	Linen Classic
HP-P3	Linen Crisp
HP-P4	Linen Flax

Wood Grain

HP-AM	Amber Cherry
HP-KA	Brazilwood
HP-KG	Columbian Walnut
HP-KP	Field Elm
HP-KN	Grey Elm
HP-KM	Landmark Wood
HP-AE	Maple
HP-AD	Medium Cherry
HP-KL	Neo Walnut
HP-KC	New Age Oak
HP-KR	Phantom Ecru
HP-KS	Phantom Pearl
HP-KD	River Cherry
HP-KE	Sanara
HP-KF	Williamsburg Cherry

Ply-Edge

HP-PW	Ply-Edge
-------	----------

## Trim Color

TR-IE	Accent Orange
TR-F	Black
TR-RR	Rusty Red
TR-PLS	Smooth Plaster

## Painted MDF

PW-R	Beige
PW-F	Black
PW-AK	Chalk
PW-G	Graytone
PW-PL	Polar
PW-RR	Rusty Red
PW-1J	Sky Blue
PW-SP	Sparrow
PW-SY	Stormy
PW-ST	Straw
PW-1H	Terra
PW-VA	Vapor

## Thread Colors

NS-1E	Accent Orange
NS-F	Black
NS-RR	Rusty Red
NS-PLS	Smooth Plaster

**ALERT:** These materials are current, however they are being considered for future obsolescence due to low volume.

<b>Wood:</b>	
VR-W12	Naturally
WF-RC	Sorrel Double Cut
<b>Laminate:</b>	
H-EK	Owl Nest
H-EC	Quail Nest
H-EA	Robin Nest
H-DE	Wheat Grain

**Forest Stewardship Council (FSC) Statement:**  
In our continuing support of sustainable forestry and responsible purchasing, Haworth North America is offering FSC certified wood products at no up-charge. By providing FSC certified material, Haworth is supporting our client's green building goals and demonstrating our collective commitment to source materials more sustainably.  
Haworth will provide to you the necessary FSC-certified paperwork with your shipment. For more information, FAQs, and a complete FSC product list (including product exceptions), go to the Library and search FSC.

# Fabrics/Color Legends

Ⓧ = Directional fabric

Fabric and finish availability as well as technical information are subject to change; refer to Surfaces.Haworth.com for current information.

Haworth seating models are restricted to fabric patterns that meet applicability standards for tailoring. A dot in the matrix below indicates fabric acceptability on seating series or specific models listed. Fabrics are listed alphabetically by grades.

Grade: Pattern (Surface Code)	Model		
	Seating	Pillows	Screens
<b>Fabrics</b>			
A: Blanket (4H)	●	●	
A: Horizon (1N)	●	●	
A: Morse (4J)	●	●	
A: Pixel (2A)		●	
A: Tellure (3A)	●	●	
A: Twist (MM)		●	
A: Wellington Faux Leather (XJ)	●		
B: Align (4F)		●	
B: Diagonale (4N)	●	●	
B: Dottie (ME)		●	
B: Element (4Z)	●	●	
B: English Tweed (4E)		●	
B: Floyd by Kvadrat	●	●	
B: Gauge (1X)	●	●	
B: Jewel (MN)		●	
B: Kaleidoscope (S4)	●	●	
B: Leef (ML)		●	
B: Ramie (4V)	●	●	
B: Squares (RA)	●	●	
B: Tech (MV)	●	●	
C: Cocktail (1W)		●	
C: Dots (6K)	●	●	
C: King (LH)			●
C: Maya (LM)			●
D: Atlas by Kvadrat (LW)	●	●	
D: Big Arrow (4D)	●	●	
D: Big Diagonale (1K)	●	●	
D: Clara 2 by Kvadrat (NV)	●	●	
D: Class (LE)			●
D: Cotswold (JB)	●	●	
D: Main Line Flax (6M)	●	●	
D: Melange Nap by Kvadrat	●	●	
D: Recheck by Kvadrat (RP)	●	●	
D: Tangram (LV)	●	●	
E: Brisa Faux Leather (XG)	●		
<b>Leathers</b>			
A: Plains Leather (XP)	●		
B: Nature Leather (XE)	●		

**Fabric Grade: A** Ⓧ  
**BLANKET**  
**50% Post Consumer Recycled Polyester, 50% Virgin Polyester**  
 4H-BE Beach  
 4H-BD Bindle  
 4H-CL Cloak  
 4H-FE Feather  
 4H-FW Firewheel  
 4H-FT Fort  
 4H-GR Grass  
 4H-HD Hood  
 4H-MA Mackinaw  
 4H-MT Manta  
 4H-PN Picnic  
 4H-PC Poncho  
 4H-SW Swag  
 4H-SP Sweep  
 4H-TK Tuck  
 4H-YA Yawn

**Fabric Grade: A** Ⓧ  
**HORIZON**  
**100% Polyester**  
 1N-001 Beeline  
 1N-004 Birdseye  
 1N-003 Border  
 1N-002 Compass  
 1N-005 Panorama  
 1N-008 Skyline  
 1N-006 Sweep  
 1N-007 Vista

**Fabric Grade: A** Ⓧ  
**MORSE**  
**100% Polyester**  
 4J-BP Blip  
 4J-CA Cable  
 4J-CD Code  
 4J-DA Dash  
 4J-DT Dot  
 4J-MA Marconi  
 4J-RA Radio  
 4J-SS S.O.S.  
 4J-SC Scribe  
 4J-TA Tap  
 4J-TE Telegraph  
 4J-TR Transmit  
 4J-WL Wireless

**Fabric Grade: A** Ⓧ  
**PIXEL**  
**51% Polyester, 32% Post Industrial Recycled Polyester, 17% Post Consumer Recycled Polyester**  
 2A-BY Byte  
 2A-DC Dice  
 2A-DT Dot  
 2A-EA Easel  
 2A-FT Flaunt  
 2A-FC Focus  
 2A-FL Folio  
 2A-HM Home  
 2A-IK Ikon  
 2A-IM Imagine  
 2A-ND Node  
 2A-PM Pomp  
 2A-RA Raster  
 2A-SP Spectral  
 2A-TA Tab  
 2A-VE Vertex

**Fabric Grade: A**  
**TELLURE**  
**100% Polyester**  
 3A-31 Aegean  
 3A-18 Black  
 3A-45 Buff  
 3A-53 Cayenne  
 3A-40 Chocolate  
 3A-49 Dove  
 3A-28 Dynamo  
 3A-54 Goose  
 3A-23 Jodhpurs  
 3A-33 Miami  
 3A-19 Navy  
 3A-06 Nickel  
 3A-34 Ocean  
 3A-46 Parrot  
 3A-50 Peel  
 3A-47 Pumpkin  
 3A-44 Roan  
 3A-51 Rust  
 3A-37 Spring  
 3A-48 Sprout  
 3A-52 Sunset  
 3A-43 Tomato

**Fabric Grade: A** Ⓧ  
**TWIST**  
**80% Post Consumer Recycled Polyester, 20% from Rayon Bamboo**  
 MM-AS And Shout  
 MM-C Coil  
 MM-CS Corkscrew  
 MM-CU Curl  
 MM-D DNA  
 MM-I Ivy  
 MM-P Plot  
 MM-SW Sidewinder  
 MM-S Snail  
 MM-SP Spire  
 MM-WH Whirlpool  
 MM-W Winding

**Fabric Grade: A**  
**WELLINGTON**  
**FAUX LEATHER**  
**100% Polyurethane**  
 XJ-AG Apple Green  
 XJ-BA Balsa  
 XJ-BT Baltic  
 XJ-BL Black  
 XJ-BR Bordeaux  
 XJ-BU Buff  
 XJ-CH Chili  
 XJ-EL Elephant  
 XJ-GR Grape  
 XJ-GP Graphite  
 XJ-IR Iron  
 XJ-JA Java  
 XJ-LP Lipstick  
 XJ-LC Lucid  
 XJ-LG Luggage  
 XJ-NM Nimbus  
 XJ-PA Pacific  
 XJ-QR Quarry  
 XJ-SF Safari  
 XJ-SA Sage  
 XJ-SN Sandy  
 XJ-SM Slate  
 XJ-SW Snow  
 XJ-SL Steel  
 XJ-ST Storm  
 XJ-SR Straw  
 XJ-TA Tangelo  
 XJ-TH Thunder  
 XJ-TS Tusk  
 XJ-WI Wine

**Fabric Grade: B**  
**ALIGN**  
**97% Post Industrial Recycled Nylon, 3% Post Consumer Recycled Nylon**  
 4F-AR Array  
 4F-FC Focus  
 4F-LM Limerick  
 4F-OR Orient  
 4F-PK Picket  
 4F-RT Root  
 4F-SC Scrimmage  
 4F-SP Spring  
 4F-TA Tangent  
 4F-TL Tree Line  
 4F-WR Wire

**Fabric Grade: B** Ⓧ  
**DIAGONALE**  
**16% Nylon, 84% Polyester**  
 4N-AC Across  
 4N-BA Bias  
 4N-CH Chevron  
 4N-CR Crosscut  
 4N-DA Diamond  
 4N-FE Featherstitch  
 4N-HT Half Timber  
 4N-KC Kitty Corner  
 4N-MA Matrix  
 4N-OB Oblique  
 4N-SE Serge  
 4N-ST Slant  
 4N-SH Slash  
 4N-SL Slope  
 4N-WC Whipcord  
 4N-ZZ Zig Zag

**Fabric Grade: B** Ⓧ  
**ELEMENT**  
**76% Post Consumer Recycled Polyester 24% Rayon**  
 4Z-ER Earth  
 4Z-ES Essence  
 4Z-FR Fire  
 4Z-FS Fossil  
 4Z-HR Herbal  
 4Z-LG Logic  
 4Z-LY Lyrical  
 4Z-PL Pillar  
 4Z-PT Poetic  
 4Z-RR Rare  
 4Z-RT Root  
 4Z-SC Scenic  
 4Z-TH Thread  
 4Z-TM Timeless  
 4Z-TR Truth  
 4Z-WN Wind

**Fabric Grade: B** Ⓧ  
**ENGLISH TWEED**  
**92% Polyester, 5% Post Industrial Recycled Polyester, 3% Post Consumer Recycled Polyester**  
 4E-BS Biscuit  
 4E-BL Blimey  
 4E-BN Bonnet  
 4E-CT Cottage  
 4E-DW Doctor Who  
 4E-FX Fox  
 4E-ML My Lady  
 4E-XD Oxford  
 4E-PE Pipe  
 4E-SH Sherry  
 4E-SN Stilton  
 4E-ST Stout  
 4E-TE Tea  
 4E-TU Tudor

**Fabric Grade: B** Ⓧ  
**FLOYD BY KVADRAT**  
**50% Polyester, 45% New Wool, 5% Nylon**  
 S6-A 123  
 S6-C 143  
 S6-D 263  
 S6-E 623  
 S6-F 663  
 S6-H 723  
 S6-J 783  
 S6-K 943  
 S6-L 1450  
 S6-M 1620  
 S6-N 1660  
 S6-P 1720  
 S6-R 1760  
 S6-T 1370  
 S6-V 1970  
 S6-W 1140

**Fabric Grade: B** Ⓧ  
**GAUGE**  
**100% Recycled Polyester**  
 1X-05 Depth  
 1X-04 Gas  
 1X-11 Narrow  
 1X-08 Pressure  
 1X-02 Rain  
 1X-12 Sea  
 1X-13 Standard  
 1X-10 Test  
 1X-03 Time  
 1X-09 Water  
 1X-06 Weather  
 1X-01 Wind  
 1X-07 Wire

# Fabrics/Color Legends

**Fabric Grade: B** <sup>(d)</sup>  
**JEWEL**

77% Post Industrial  
Recycled Polyester,  
23% Post Consumer  
Recycled Polyester

MN-AM	Amber
MN-A	Aquamarine
MN-C	Citrine
MN-E	Emerald
MN-G	Garnet
MN-J	Jade
MN-M	Malachite
MN-R	Ruby
MN-S	Sapphires
MN-TE	Tiger's Eye

**Fabric Grade: B** <sup>(d)</sup>  
**KALEIDOSCOPE**  
**100% Polyester**

S4-AG	Agate
S4-AM	Amethyst
S4-BR	Beryl
S4-CR	Carnelian
S4-CT	Citrine
S4-FL	Flourite
S4-GR	Garnet
S4-JD	Jade
S4-JS	Jasper
S4-LP	Lapis
S4-ML	Malachite
S4-MR	Marble
S4-MC	Mica
S4-MN	Moonstone
S4-LV	Olivine
S4-NY	Onyx
S4-PL	Opal
S4-PR	Peridot
S4-RB	Ruby
S4-SL	Silver
S4-SP	Spinel
S4-TR	Travertine
S4-UL	Ultramarine
S4-ZR	Zircon

**Fabric Grade: B** <sup>(d)</sup>  
**LEEF**

49% Post Industrial  
Recycled Polyester  
51% Post Consumer  
Recycled Polyester

ML-A	Aspen
ML-B	Beet
ML-C	Coca
ML-CN	Coconut
ML-F	Fennel
ML-HE	Henna
ML-H	Hosta
ML-HY	Hydrangea
ML-M	Moonflower
ML-PE	Petunia
ML-P	Pumpkin
ML-S	Sunflower
ML-V	Violet

**Fabric Grade: B** <sup>(d)</sup>  
**RAMIE**

62% Polyester,  
25% Post Industrial  
Recycled Polyester,  
13% Post Consumer  
Recycled Polyester

4V-BS	Basket
4V-BT	Bast
4V-FX	Foxtail
4V-GN	Gunnite
4V-HY	Hay
4V-MC	Macrame
4V-ML	Millet
4V-MB	Mulberry
4V-RN	Rain
4V-RD	Reed
4V-RT	Root
4V-SC	Sack Cloth
4V-SS	Sisal
4V-TH	Thatch
4V-WT	Water
4V-WD	Weed

**Fabric Grade: B** <sup>(d)</sup>  
**SQUARES**

100% Polyester

RA-CL	Colony
RA-CP	Copley
RA-FR	Farragut
RA-FN	Fountain
RA-FK	Franklin
RA-FD	Freedom
RA-HR	Harvard
RA-JC	Jackson
RA-KN	Kendall
RA-LF	Lafayette
RA-MD	Madison
RA-MR	Market
RA-NG	Niagara
RA-OT	Old Town
RA-PR	Pershing
RA-PO	Post Office
RA-TM	Times
RA-UN	Union
RA-WS	Washington

**Fabric Grade: B** <sup>(d)</sup>  
**TECH**

80% Post Consumer  
Recycled Polyester,  
20% Rayon Bamboo

MV-AI	A.I.
MV-AN	Anatomy
MV-A	Aviation
MV-B	Bionics
MV-C	Cosmos
MV-D	Disc
MV-E	Electric
MV-F	Forestry
MV-L	Logic
MV-P	Optics
MV-RA	Radio
MV-R	Rocket
MV-SF	Sci-Fi
MV-S	Skill
MV-T	Theory
MV-Z	Zoology

**Fabric Grade: C** <sup>(d)</sup>  
**DOTS**

72.7% Post Consumer  
Recycled Polyester  
27.3% Post Industrial  
Recycled Nylon

6K-CL	Clay
6K-VY	Ivy
6K-LM	Lemon
6K-MN	Mandarin
6K-MS	Mist
6K-NG	Night
6K-SH	Shadow
6K-WT	Water

**Fabric Grade: C** <sup>(d)</sup>  
**KING**

100% Polyester

LH-BE	Beige
LH-DB	Dark Blue
LH-DG	Dark Green
LH-DM	Dark Mustard
LH-GD	Gold
LH-GL	Light Green
LH-LG	Light Grey
LH-MB	Medium Blue
LH-MG	Medium Grey
LH-RG	Orange
LH-RD	Red
LH-WG	Warm Grey

**Fabric Grade: C** <sup>(d)</sup>  
**MAYA**

100% Polyester

LM-DB	Dark Blue
LM-GY	Golden Yellow
LM-GR	Green
LM-MG	Medium Cool Grey
LM-WG	Medium Warm Grey
LM-RG	Orange

**Fabric Grade: D** <sup>(d)</sup>  
**ATLAS BY KVADRAT**

90% New Wool,  
10% Nylon

LW-A	131
LW-B	151
LW-C	181
LW-D	361
LW-E	461
LW-F	471
LW-G	501
LW-H	531
LW-J	561
LW-K	571
LW-L	621
LW-M	631
LW-N	651
LW-P	671
LW-Q	771
LW-R	861
LW-S	881
LW-T	931
LW-V	951

**Fabric Grade: D** <sup>(d)</sup>  
**BIG ARROW**

100% Post Consumer  
Recycled Polyester

4D-BS	Bisque
4D-BL	Blue
4D-CN	Cool Neutral
4D-DB	Dark Blue
4D-GD	Gold
4D-GR	Green
4D-MG	Medium Grey
4D-RE	Red
4D-SA	Salmon
4D-WN	Warm Neutral

**Fabric Grade: D** <sup>(d)</sup>  
**BIG DIAGONALE**

66% Post Consumer  
Recycled Polyester  
34% Post Industrial  
Recycled Polyester

1K-AM	Amber
1K-BL	Balsam
1K-CR	Carbon
1K-ER	Earth
1K-HN	Henna
1K-MN	Mineral
1K-PR	Parrot
1K-RD	Red
1K-RS	Rose
1K-SE	Sea
1K-TR	Terracotta
1K-ZF	Zaffer

**Fabric Grade: D**  
**CLARA 2 BY KVADRAT**

92% New Wool, 8% Nylon

NV-A	144
NV-B	148
NV-C	184
NV-D	188
NV-E	244
NV-F	248
NV-G	273
NV-H	277
NV-J	384
NV-K	388
NV-L	423
NV-M	427
NV-N	544
NV-P	548
NV-Q	643
NV-R	647
NV-S	793
NV-T	797
NV-V	884
NV-W	888
NV-X	983
NV-Y	987

**Fabric Grade: D** <sup>(d)</sup>  
**CLASS**

100% Polyester

LE-DG	Dark Grey
LE-GR	Green
LE-GM	Green Multi
LE-LN	Light Cool Neutral
LE-MB	Medium Blue
LE-MN	Medium Warm Neutral
LE-RR	Reddish Orange

**Fabric Grade: D**  
**COTSWOLD**

100% Wool

JB-AB	Abertay
JB-AN	Anquilla
JB-DM	Dartmouth
JB-EH	Edgehill
JB-ED	Editor Blue
JB-GS	Goldfish
JB-HA	Heart
JB-NE	Nettle Bellflower
JB-PL	Pickeral Weed
JB-ST	Scottsdale
JB-SD	Silver Dollar
JB-SU	Silverbush
JB-SC	Soft Charcoal
JB-TR	Tree
JB-WE	Wheaton
JB-WO	Woodcroft

**Fabric Grade: D** <sup>(d)</sup>  
**MAIN LINE FLAX**

70% Virgin Wool  
30% Flax

6M-AL	Aldgate
6M-AR	Archway
6M-BN	Bank
6M-BY	Bayswater
6M-BT	Bethnal
6M-BR	Brompton
6M-CM	Camden
6M-GL	Goldhawk
6M-LM	Lambeth
6M-LY	Leyton
6M-MN	Monument
6M-ST	Stanmore
6M-TM	Temple
6M-TW	Tower
6M-TF	Tufnell
6M-WS	Westminster

**Fabric Grade: D** <sup>(d)</sup>  
**MELANGE NAP BY KVADRAT**

97% New Wool,  
3% Nylon

S7-A	111
S7-C	171
S7-D	191
S7-E	211
S7-F	221
S7-H	241
S7-J	321
S7-K	461
S7-L	521
S7-M	711
S7-N	771
S7-P	791
S7-R	911
S7-T	951
S7-V	1540

**Fabric Grade: D** <sup>(d)</sup>  
**RECHECK BY KVADRAT**

90% New Wool, 10% Nylon

RP-A	115
RP-B	125
RP-C	145
RP-D	165
RP-E	455
RP-F	565
RP-G	625
RP-H	645
RP-J	725
RP-K	745
RP-L	765
RP-M	775
RP-N	785
RP-P	845
RP-Q	875
RP-R	965
RP-S	985

**Fabric Grade: D** <sup>(d)</sup>  
**TANGRAM**

57% Polyester,  
28% Post Industrial  
Recycled Polyester,  
15% Post Consumer  
Recycled Polyester  
(43% REPREVE®)

LV-CL	Clue
LV-EN	Enigma
LV-GU	Guess
LV-MA	Maze
LV-MU	Muse
LV-MT	Mystery
LV-MY	Mystify
LV-UT	Outline
LV-PE	Perplex
LV-PC	Pieces
LV-PU	Puzzle
LV-RD	Riddle
LV-SC	Scrabble
LV-SL	Solve
LV-TE	Teaser
LV-TR	Trick



# Fabrics/Color Legends

**Fabric Grade: E** <sup>(d)</sup>  
**BRISA FAUX LEATHER**  
**100% Polyurethane face,**  
**65% Polyester,**  
**35% Rayon Backing**

XG-22 Ash  
 XG-36 Beet Root  
 XG-12 Black Onyx  
 XG-30 Blue Sea  
 XG-5 Cambridge Blue  
 XG-35 Cinnabar  
 XG-34 Esmeralda  
 XG-33 Iceberg  
 XG-29 Mineral  
 XG-31 Moon  
 XG-18 Night Navy  
 XG-21 Pompeian Red  
 XG-27 Shitake  
 XG-13 White  
 XG-32 Wishbone

**Leather Grade: A**  
**PLAINS LEATHER**

XP-KX Atlantis  
 XP-KC Black  
 XP-KY Brown  
 XP-KZ Smoke  
 XP-KW Storm

**Leather Grade: B**  
**NATURE LEATHER**

XE-AS Bark  
 XE-AR Bittersweet  
 XE-AP Chocolate  
 XE-AJ Cream  
 XE-AH Flint  
 XE-AK Ink  
 XE-AX Oats  
 XE-AT Saddle  
 XE-AM Seal  
 XE-AL Shadow  
 XE-AW Truffle  
 XE-AN White

**ALERT:** These materials are current, however they are being considered for future obsolescence due to low volume.

**Fabric Grade: B** <sup>(d)</sup>  
**DOTTIE**

**89% Post Industrial**  
**Recycled Polyester,**  
**11% Post Consumer**  
**Recycled Polyester**

ME-CA Calico  
 ME-C Chads  
 ME-DD Dew Drops  
 ME-F Flecks  
 ME-M Morse  
 ME-P Pip  
 ME-PD Polka Dots  
 ME-R Roulette  
 ME-T Tabby  
 ME-Y Yahtzee

**Fabric Grade: C** <sup>(d)</sup>

**COCKTAIL**  
**100% Eco-Intelligent\***  
**Polyester**

**MBDC Cradle to Cradle Gold**

1W-12 Black Cow  
 1W-08 Blue Moon  
 1W-13 Boilermaker  
 1W-01 Bubbly  
 1W-03 Gibson  
 1W-04 Grasshopper  
 1W-07 Lounge  
 1W-16 Margarita  
 1W-10 Martini  
 1W-14 Mojito  
 1W-11 Old Fashion  
 1W-06 Pink Squirrel  
 1W-15 Sidecar  
 1W-09 Stinger  
 1W-02 Stout  
 1W-05 Swizzle

### Haworth Alliance

For information on the Haworth Alliance Program, please refer to:  
[surfaces.haworth.com](http://surfaces.haworth.com)

### Customer's Own Material (COM)

For Customer's Own Material (COM) information including requesting a new COM, please refer to:  
[surfaces.haworth.com](http://surfaces.haworth.com)

# North American Terms of Sale

**These Terms of Sale are part of a quotation, bid response, or other sales document issued by Haworth, Inc., Haworth, Ltd. ("Haworth").**

**These Terms of Sale do not cover products manufactured in North America shipping to non-North American countries nor do they cover products manufactured in non-North American countries shipping to North America. For those terms of sale, please contact Haworth's Global Trade and Compliance Department at 616.393.3000 or through Haworth.com.**

## A. Ordering Information

Haworth sells its products on the terms set forth in these standard Terms of Sale:

ORDERS MUST BE SUBMITTED IN WRITING OR ELECTRONICALLY (Lynx) AS REPRESENTED BY A VALID PURCHASE ORDER, WHICH INCLUDES PRODUCT TOTAL.

An order is not binding upon Haworth until Haworth issues an order acknowledgment to the customer (the "Customer"), which will include price information and an anticipated delivery date.

### 1. Order Changes/Cancellations

For Specials, Customer's Own Material (C.O.M.), finish matches, custom colors, custom products, Master lock and key orders, and RUSH orders, no changes or cancellations are allowed 24 hours after order placement. All other products require approval for changes or cancellations. A change/cancellation fee may apply. Contact Order Services for applicable charges.

Ship-to addresses changed within five (5) business days of delivery will incur fees to cover administrative costs due to re-labeling of product and/or reconsignment fees with the carrier.

Order cancellations are complete annulments of orders. Order changes are the deletion of line items or a change in size, color, quantity, ship-to address, or scope of work. There is no penalty for additions; however, any change may cause the order or the line items affected to be rescheduled. Order changes involving additional product and services which increase the value must be accompanied by an amended Purchase Order or other document as agreed.

ALL CHANGES MUST BE IN WRITING, REGARDLESS OF THE (DOLLAR) VALUE. CHANGES ARE NOT BINDING UPON HAWORTH UNTIL HAWORTH ISSUES AN ACKNOWLEDGMENT OF THE CHANGE.

### 2. C.O.M. (Customer's Own Material)

A Customer who requests a fabric, surface or finish material (C.O.M.) not in Haworth's standard finish offering must first confirm approval of or request new approval for the C.O.M.

Haworth will determine feasibility of the material for manufacturability. For a description of the procedure to submit C.O.M. samples, contact Haworth's Order Services department. For testing information, see the C.O.M. section of the catalog, or call Haworth Order Services.

If Haworth agrees to use the C.O.M., (1) Haworth shall have no responsibility for the condition, quality, value, performance, physical properties, or any other aspect of the C.O.M.; and (2) Haworth shall have no liability for any damages, injuries, or losses to the Customer or to any third party that shall be caused by any C.O.M., and the Customer shall hold Haworth harmless for all such liability.

### 3. Valid/Complete Purchase Order

The following information is required in order to process an order with Haworth:

#### a. Customer Information

- i. **Sold To:** Legal name, complete address (if Haworth is to bill the end user, provide end user Purchase Order made out to Haworth, Inc., Haworth, Ltd.) and phone and fax number.
- ii. **Ship To:** Legal name and address.
- iii. **Purchase Order Number:** From the party Haworth will be billing.
- iv. **Authorized Signature:** All Purchase Orders must be signed by a duly authorized representative if a signature line is present. Electronically transmitted Purchase Orders will be accepted without a signature if dealer billed and the dealer has an electronic purchase payment agreement on file.
- v. **Contact Name and Phone Number:** Person Haworth should contact with any questions regarding the order.
- vi. **Shipping Contact:** Name and phone number of person to be contacted regarding shipping and delivery matters.
- vii. **Tagging Instructions:** This information will appear on all documentation received from Haworth including: cartons, acknowledgments, and invoices.
- viii. **Price Agreement or National Sales Agreement Number**
- ix. **Product Total:** Net dollars.
- x. **Installation, Design, Project Management, and/or Service Fees**

#### b. Product Information

- i. **Quantity**
- ii. **Product Numbers**
- iii. **Colors**
- iv. **Specials:** Specify special part number for new special products.
- v. **Customer's Own Material:** Order entry code, manufacturer, pattern, and color.

- vi. **Approval Drawings:** An authorized signature by a duly authorized representative is required for shop drawings when applicable.
- vii. A deposit may be required for custom materials.

#### c. Order Confirmation

All orders will be acknowledged.

## B. Pricing Policies

### 1. Terms of Payment

Terms of payment and credit limits will be established based on financial information. Standard payment terms on open credit are net thirty (30) days from invoice date. Advance payments or other payment security may be required by Haworth. The account balance must be at or below the credit limit and current at all times (no past-due balances). Haworth reserves the right to delay or cancel any delivery to a Customer whose Haworth account balance is over the credit limit and/or past due. For walls and floors a deposit will be required.

### 2. Terms of Credit

Customer hereby authorizes Haworth to obtain such credit reports, financial information or other information as Haworth may request, including, without limitation, credit information from any financial institutions or others having a business relationship with the Customer. Customer hereby authorizes any credit references to answer Haworth's inquiries and provide such credit information and documentation as Haworth may request.

The Customer hereby releases and holds Haworth harmless for any inconvenience whatsoever, caused by any temporary or permanent withdrawal or restriction of credit privileges hereunder, or the enforcement of any of the provisions contained in this paragraph.

### 3. Past-Due Charges

Past-due balances will be increased by a maximum of 1.5% per month, or 18% annually, without forfeit of Haworth's right to immediate payment.

### 4. Applicable Prices

**The price of any product sold to Customer by Haworth will be based upon the North American Price List (Catalog).**

Prices and discounts are subject to change without notice or approval. In the event of an adjustment to pricing, National Sales Agreement (NSA) Customers will be notified in advance according to the terms of the NSA.

Applicable prices and currency exchange rates are those in effect at the time of the RECEIPT of an ORDER; Haworth reserves the right to use the published pricing effective at the time of shipment, if the requested delivery date is more than 120 days after the order receipt date.

## North American Terms of Sale

Haworth Flooring products are sold using the North American price list in US dollars. Currency exchange rates at the time of the transaction will be used to convert the USD amount into the alternate currency. Should the currency exchange rate between the USD and alternate currency change between a quote and the receipt of an order, the alternate currency amount will also change to equal the current, equivalent USD amount.

### 5. C.O.M. (Customer's Own Material) Charges

Refer to appropriate Customer's Own Material (C.O.M.) form for applicable surface material charges.

### 6. Taxes

Haworth prices do not include customs duty, sales, use, value added or similar taxes. Any federal, state/provincial or other taxes or assessments based upon the sale or delivery of products or services sold applicable to the customer at present or later imposed by federal, state/provincial or municipal agencies, shall be added and paid by the customer. Customer is responsible for all such taxes.

**NOTE:** For all countries a valid sales tax exemption certificate must be approved by and on file with Haworth prior to product shipment. Otherwise, sales tax will be due and payable to Haworth when such tax is invoiced to Customer.

### 7. Services

If, as a result of Customer request, the Haworth dealer or Haworth subsidiary provides planning/design services, storage, project management, special handling, set-up, installation and/or other services, the Customer will be charged at the local Haworth dealer/subsidiary's prevailing rates.

### 8. Termination by Haworth

Haworth may immediately terminate an order upon written notice in the event bankruptcy or insolvency proceedings are instituted by or against the Customer, or the Customer is adjudicated as bankrupt, becomes insolvent, makes an assignment for the benefit of creditors, or proposes or makes any arrangements for the liquidation of its debts, or a receiver or receiver and manager is appointed with respect to all or any part of the assets of the Customer.

## C. Shipping and Delivery

Haworth will have the right to determine the method of shipment and routing of product.

If, for any reason, a delivery has to be made to an intermediate location (i.e. a location other than the "Ship To" location noted on the order or ultimate end user location), all handling and re-delivery costs incurred would be at the Customer's expense.

### 1. U.S.A. - Contiguous

All deliveries will be CPT (Carriage Paid To) (ICC Incoterms 2010) Haworth's manufacturing facilities or distribution centers. Freight charges will be prepaid by Haworth on all orders to locations within the continental United States. Customer bears all risk of loss or damage to the goods when they are placed on Haworth's means of transport.

### 2. U.S.A. - Non-contiguous (Alaska, Hawaii and Puerto Rico)

All deliveries will be CIF (Cost, Insurance and Freight) (ICC Incoterms 2010). Haworth's catalog prices include ocean freight and insurance to the port of the final destination. Haworth has the right to determine the carrier, method of shipment and routing. Haworth will contract with the insurer and provide minimal insurance coverage (CIF @ 110%) made payable to the Customer. Customer is responsible to obtain greater insurance if so desired.

Customer bears all risk of loss or damage to the goods when the goods are effectively at the disposal of the Customer on board the vessel at the named port of destination. Proof of delivery is a clean on board bill of lading. Customer will be responsible for all on-carriage from the receiving port to the final destination.

### 3. Canada

All deliveries will be DDP (Delivered Duty Paid) (ICC Incoterms 2010). Haworth's catalog prices include delivery to Customer's named place, not unloaded from any arriving means of transport. Customer bears all risk of loss or damage to the goods when they are delivered to the Customer's named facility not unloaded. Haworth will assume responsibility to file all freight claims with the carrier for any loss/damage which may occur while product is in transit, and will promptly repair or replace any damaged or lost product. Haworth requires the Customer to report all freight damage and/or loss to both the carrier and to Haworth.

**NOTE:** Under all delivery terms (U.S.A. and Canada), any additional expense resulting from Customer's request for expedited transportation, special services, packaging, handling, routing, and/or shipping method will be billed to Customer.

### 4. Mexico

All deliveries will be DAP (Delivered to Place) (ICC Incoterms 2010). Haworth's catalog prices include freight charges for normal surface transportation to a United States point of exportation within the 48 contiguous states. Haworth has the right to determine the carrier, method of shipment and routing.

Customer bears all risk of loss or damage to the goods when the goods are delivered to the named United States point of exportation. Haworth will provide customs clearance facilitation and arrangement of local delivery through an Authorized Dealer in Mexico, on a separately negotiated basis. Otherwise the Customer will be responsible for all customs clearance formalities and on-carriage from the United States point of exportation to the final destination in Mexico.

### 5. Delivery Dates and Delay

If Haworth cannot deliver products as scheduled due to causes beyond its reasonable control (such as casualty, labor disputes, or accident; inability to obtain necessary labor, material or transportation; or changes requested by the Customer), the delivery date will be extended to compensate for the delay as determined by Haworth.

### 6. Delivery Shortages and Damage

Product shortages and damage must be noted on delivery receipts at the time of delivery and reported to the carrier for correction.

Claims against Haworth for shortages, errors, or damage must be made within ten (10) days of the date of delivery or the Customer waives the right to make such a claim. Signed Bill of Ladings or Delivery Receipt must be sent in with claims. See the Haworth/Haworth Dealers Roles and Responsibilities document for further details.

### 7. Storage

Haworth may transfer product to storage at the Customer's risk and expense if the Customer is unable or unwilling to take delivery of product as originally scheduled. Upon such transfer to storage, the Customer assumes risk of loss. Haworth will invoice the Customer for storage fees and the Customer will make payments in accordance with Haworth's standard payment terms.

# North American Terms of Sale

## D. General Terms

### 1. Governing Law

For products purchased for delivery in the U.S. pursuant hereto, this Agreement shall be governed by and construed according to the laws of the State of Michigan. Where Products are purchased for delivery in Canada pursuant hereto, this Agreement shall be governed by and construed according to the laws of the Province of Alberta. In either case, the parties attorn to the exclusive jurisdiction of the courts of Michigan and Alberta, respectively for the purpose of hearing any disputes arising under this Agreement or with respect to any Products sold pursuant hereto, and agree that the provisions of the United Nations Convention on Contracts for the International Sale of Goods and any other provision or law which would have the effect of applying the laws of any jurisdiction other than Michigan or Alberta, as the case may be, shall be excluded.

### 2. Force Majeure

In the event that the performance of Customer or Haworth or its participating dealer assignee(s) would be prevented, restricted, interfered with or rendered commercially impracticable by reason of Force Majeure, then upon the giving of notice to the other parties, the party affected by the Force Majeure shall be excused from performing hereunder until the Force Majeure no longer prevents, restricts, interferes with, or renders such performance commercially impracticable.

"Force Majeure" shall mean: fire, explosion, breakdown of plant, epidemic, hailstorm, snow/ice storms en route, hurricane, tornado, cyclone, flood or power failure; war, revolution, civil or military disturbances, acts of public enemies, acts of terrorism, blockade or embargo; any law, order, proclamation, regulation, ordinance, demand or requirement of any applicable governmental authority or any subdivision, authority, or representative of any such government; labor difficulties, including without limitation, strikes, slowdowns, picketing or boycotts; or difficulties beyond Haworth's reasonable control in obtaining necessary raw materials, labor, fuels and electric power, components or facilities, and any other circumstances beyond the control of the party affected.

### 3. Delays by Customer

Where Haworth has not received adequate site dimensions, Product specifications, shipping information, installation particulars or other information required by Haworth to permit the efficient manufacture of any Products, or where site conditions are not in accordance with the Installation Requirements set forth, or are not otherwise suitable to permit effective and efficient installation, the manufacture and/or delivery of Products may be delayed, and such event shall constitute a delay by the Customer. When manufacture, delivery or installation is delayed by the Customer or at the Customer's request: (i) Haworth may, at its option, present the invoice for the full price of the Products to the Customer as then due and payable; (ii) the Customer shall pay to

Haworth all reasonable storage, handling and other reasonable incidental expenses incurred by Haworth in connection with such delay; and (iii) the Customer shall bear all risk of loss or damage to the Products being held by Haworth for the Customer.

### 4. Use and Installation of Products

Haworth recommends that its products be installed by certified, qualified and approved installers according to Haworth's written installation procedures. The Customer agrees to use Haworth products properly; not to remove or alter safety devices, warnings, or operation instructions placed on products by Haworth, and to instruct employees as to the proper care and use of the products according to printed instructions.

### 5. Warranty

Haworth's standard North American Warranty will apply as appropriate. All product line warranty specifics are available in each catalog or upon request.

## E. Services

Service requests for design, installation, relocation, storage, etc. are handled by the local Haworth dealer on a separately negotiated basis. Contact the local Haworth dealer, affiliate or area sales office for more details.

### Scope of Work - Design

Customer acknowledges that the Products to be manufactured or procured by Haworth in connection with the order are or may be custom manufactured for the Customer and that Haworth may be required to perform extensive work in relation to the design and specification of such Products. Where Customer requests that Haworth create as-built drawings or make more than two material revisions to any particular Product design or specification, Customer agrees that Haworth shall be entitled to invoice Customer with respect to such additional work on the basis of Haworth's then prevailing rates for related design and specification services.

### Installation Requirements

Where installation services are to be provided by Haworth, its authorized dealer or subcontractor, a document will be provided setting forth the scope of installation work to be performed (the "Scope of Work") and the price to be charged therefore. Unless otherwise specified in the scope of work, Haworth's installation services are limited to products sold by Haworth with the exception of lighting, under floor electrical and data.

## General Conditions

(a) Sufficient time shall be allocated by the Customer following delivery of Products and prior to Customer's occupation of the premises to allow the installation of all Products during conventional working hours, Monday through Friday, 7:30 a.m. to 4:30 p.m. Where sufficient time is not allocated and Haworth is required or requested to perform installation work outside of such times, overtime charges shall be charged at Haworth's then prevailing rates. (b) Haworth shall be given free and exclusive access to; (i) a loading dock within 150' of the freight elevator or hoist, which loading dock shall be of sufficient size to enable full-size tractor-trailer deliveries to the premises (where required by Haworth); (ii) a freight elevator or hoist of sufficient size and capacity to allow the efficient movement of the Products; (iii) an unobstructed and safe pathway to the area where Products are to be stored or staged; (iv) a secure storage / staging area; (v) convenient trash facilities; (vi) adequate lighting; (vii) a work site that complies with applicable health and safety legislation. Where such areas and facilities are not available, Haworth shall be entitled to bill Customer for all amounts incurred by Haworth for double-handling, product movement, lifting, hoisting, trash removal and any other resulting charges. (c) The installation site shall be free and clear of existing furniture, debris, or other obstructions (including construction in progress) and shall otherwise be in the reasonable opinion of Haworth ready for installation of the Products. Any building where Products are to be installed shall be fully closed in, dry and protected from the natural elements, with temperatures between 40°F and 90°F (4°C and 32°C) and relative humidity not to exceed 70% at all times including receipt of products, during and after installation and shall be adequately heated and/or air-conditioned. Where unusual site conditions exist which impede or prevent the normal installation of any Products, applicable extra charges shall apply at prevailing rates. (d) Haworth's installation pricing is based upon the installation occurring as one continuous delivery and installation project. Phased installation pricing shall be provided by Haworth on a case by case basis. (e) Electrical hardwiring, plumbing and mechanical work is not included and shall be the responsibility of the Customer. (f) Except as may be otherwise specifically indicated, installation pricing does not apply to projects where union labor is required. Where Haworth has provided installation pricing on the basis that non-union labor be utilized, and where Haworth is required to use union labor or it otherwise becomes impractical to use non-union labor, or where Haworth is required by law to use prevailing wages, Haworth shall be entitled to charge the Customer for any cost differential between the anticipated cost of non-union labor and the actual cost of utilizing union or prevailing wage labor. (g) Haworth shall not be responsible for obtaining permits.

# North American Terms of Sale

---

## Project / Site Conditions

Lateral load bracing is not included in the scope of Haworth's work and shall not be performed by Haworth. In areas where flooring Products are to be installed by Haworth overhead construction must be completed prior to the commencement of such work to avoid damage to the panels and finishes. The existing subfloor must be smooth, mopped clean, free of moisture, dust, dirt and debris. Once installed, the access floor must be maintained in the same manner. The subfloor must have a maximum vertical elevation deviation of 0.375" (10mm) over a horizontal span of 10'-0" (3m), and without discontinuities in floor slope. For greater certainty, the scope of Haworth's installation work in such areas shall not be deemed to include any work required to level such subfloor, remove protrusions, remove pre-existing floor coverings or adhesives, or any other work which is required to remedy any conditions which may impede the efficient installation of flooring. Except as may be otherwise specifically indicated in the order, installation pricing for flooring Products and the Scope of Work in relation thereto shall not include any work required to remove and replace floor panels following their initial installation to provide tradespersons or others with access to the underpanel cable management cavity. In areas where movable walls are to be installed, all flooring (including carpeting) and ceiling components (including dropped ceiling grid components) shall be fully complete and ready for the installation of the movable wall products. Further, the existing floor (or other surface on which the movable wall panels are to be installed) shall have a maximum vertical deviation of 1.25" (30mm) and the dropped ceiling grid shall have a maximum vertical deviation of 0.375" (10mm) from the specifications to which such movable wall panels were designed and manufactured (collectively the "Permitted Tolerances"), and shall otherwise comply with any site condition assumptions made known to Haworth prior to the manufacture of such Products (the "Site Assumptions"). Where the Permitted Tolerances or Site Assumptions are not strictly adhered to or met, additional charges may be incurred in connection with site remediation and/or the modification or remanufacture of affected movable wall products, together with all resulting shipping and labor charges at Haworth's then prevailing rates for such Products and services.

## Installation Change Orders

Where Customer requests work to be performed or materials to be provided which are not contemplated in the Scope of Work, or Customer otherwise requests Products or services not contemplated in the order (collectively "Extras"), prior to providing such Extras Haworth reserves the right to require the Customer to provide and sign a written Purchase Order or Change Order acceptable to Haworth describing the Extras and the amounts to be charged therefore, and the Customer agrees to pay such charges.

## Entire Agreement

The order and this Agreement (including applicable Schedules) constitute the sole agreement between the parties and supercede any prior understanding or written or oral agreements between the parties (excluding National Sales Agreements). No waiver of any of the provisions of these Standard Terms and Conditions shall be binding on Haworth unless expressly agreed in writing.

**Revision Date: April 1, 2019**

# Index

Products are listed alphabetically in this index by alpha-numeric prefix/suffix codes.

<b>Product Code</b>	<b>Product Description</b>	<b>Page</b>
EURT-0000-N001CB	Bezel Utility Module .....	.25
EURT-0000-N001CW	Bezel Utility Module .....	.25
EURT-0000-N001SB	Bezel Utility Module .....	.25
EURT-0000-N001SW	Bezel Utility Module .....	.25
EURT-0072-1010	Bezel Utility Module .....	.25
EURT-0072-1100	Bezel Utility Module .....	.25
HOA1-3	Double Booth .....	.21
HOAB-2	Single Booth .....	.17
HOAC-3	Corner Booth .....	.18
HOAD-3	Double Desk .....	.15
HOAE-5	Privacy Booth .....	.19
HOAP-3	Privacy Desk .....	.16
HOAS-2	Single Desk .....	.14
HOAW-5	Conference Booth .....	.20
HOCH	Accessories – Coat Hook .....	.23
HOPD	Hideaway Power Module .....	.24
HOUP	Accessories – Pillows .....	.23
HOUS	Accessories – Soft Storage .....	.23
HOUT-1616	Height Adjustable Table .....	.22
SODB-2424-P	Sprig Tables – Round .....	.13
SODC-1616-P	Sprig Tables – Round .....	.13
SON-3	Plume Screens – Plume 3 .....	.8
SON-6	Plume Screens – Plume 6 .....	.8
SON-9	Plume Screens – Plume 9 .....	.8
SOPB-2223	Chick Pouf – Chick Pouf with Back .....	.10
SOPN-2223	Chick Pouf – Chick Pouf without Back .....	.10
SOPN-2238	Chick Pouf – Large Square - No Back .....	.11
SOPN-2252	Chick Pouf – Rectangle - No Back .....	.11
SOPN-2265	Chick Pouf – Round - No Back .....	.12
SORA-5320-P	Sprig Tables – Rectangle .....	.13
SOSR-1-RW	Feather Sofa – Feather – Asymmetrical .....	.9
SOSS-1-RW	Feather Sofa – Feather – Symmetrical .....	.9

# Great Expectations

---

You have them as a Haworth customer and so do we. And because we value our customers, we cover our products with the Haworth North America Product Compatibility and Limited Warranty Policy.

## Product Compatibility and Limited Warranty Policy

### Our Commitment To Product Compatibility – Integrated Product Platforms

As a market leader in the design and manufacture of workspaces that adapt to change, we strive to maintain product compatibility within our various generations of integrated product platforms. This benefits the customer who desires to update or modify their work environment. It also benefits the customer needing to replace a product due to damage or other reasons but which is no longer manufactured or is otherwise unavailable, such as a fabric or finish that is discontinued because of changing market preferences. In both circumstances, we often can provide products with comparable function and performance.

### Our Commitment To Product Quality – The Haworth North America Limited Warranty

To ensure customer satisfaction and peace of mind, we stand behind our products with the Haworth North America Limited Warranty. To review the current version of the limited warranty including its terms and conditions, please go to:

**[www.haworth.com/resources/product-info/warranties](http://www.haworth.com/resources/product-info/warranties)** or contact Haworth's First Call Center at **800.426.8562**.

### Warranty Requests or Questions

For questions or service requests pertaining to the Haworth Limited Warranty, please contact your Haworth dealer.

If you are unsure who your dealer is, please call Haworth's First Call Center at **800.426.8562**.

**Effective: January 1, 2020**

HAWORTH®

HAWORTH® is a registered trademark of Haworth, Inc.  
© Haworth, Inc. All rights reserved. 2020 2.20 | Item #6064  
haworth.com | 800 344 2600